



brother

Quick Reference Guide

Kurzanleitung

Guide de référence rapide

Beknopte bedieningshandleiding

Guida di riferimento rapido

Guía de referencia rápida

Guia de referència rápida

Краткий справочник

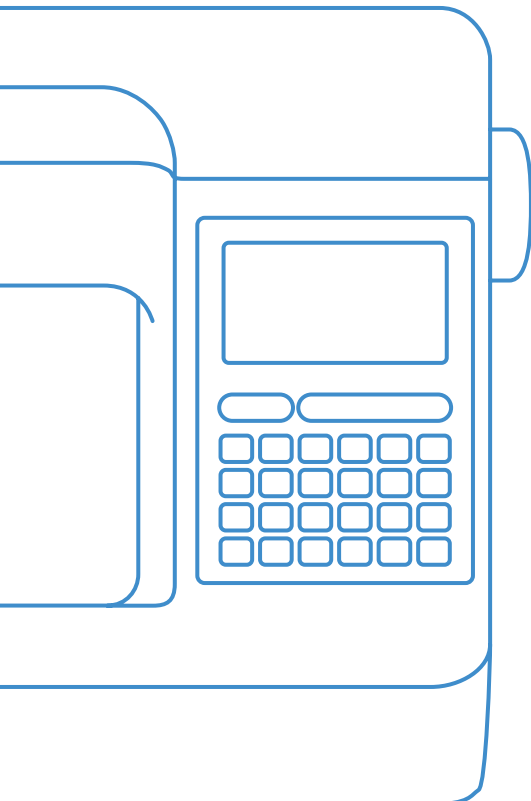

Be sure to read this document before using the machine.

We recommend that you keep this document nearby for future reference.

Lesen Sie dieses Dokument, bevor Sie die Maschine verwenden.
Es wird empfohlen, dieses Dokument griffbereit aufzubewahren, damit Sie jederzeit darin nachschlagen können.

Veillez à lire ce document avant d'utiliser la machine.
Nous vous conseillons de conserver ce document à portée de main pour vous y référer ultérieurement.

Lees dit document voordat u de machine gebruikt.
Houd dit document bij de hand, zodat u het kunt raadplegen.

Leggere questo documento prima di utilizzare la macchina.
Si consiglia di conservare questo documento a portata di mano per un eventuale riferimento futuro.

Lea este documento antes de utilizar la máquina.
Recomendamos que tenga este documento a mano por si necesita consultarlo más adelante.

Certifique-se de ler este documento antes de utilizar a máquina.
Recomendamos guardar este documento em um lugar de fácil acesso para futuras referências.

Обязательно прочитайте этот документ перед началом работы на машине!

Рекомендуется хранить данный документ в удобном месте, чтобы он был доступен для справок.

Before using your machine for the first time please read the “IMPORTANT SAFETY INSTRUCTIONS” in the Operation Manual.

Refer to the Operation Manual for detailed instructions. In this guide, English screens are used for basic explanations.

Avant d'utiliser votre machine pour la première fois, veuillez lire les « INSTRUCTIONS DE SÉCURITÉ IMPORTANTES » indiquées dans le Manuel d'instructions.

Reportez-vous au Manuel d'instructions pour des informations détaillées. Les écrans de ce guide sont en anglais pour les explications de base.

Prima di utilizzare la macchina per la prima volta, leggere “IMPORTANTI ISTRUZIONI DI SICUREZZA” nel Manuale di istruzioni.

Per le istruzioni dettagliate, consultare il Manuale di istruzioni. Nella presente guida si utilizzano le schermate in inglese per le spiegazioni di base.

Antes de utilizar a sua máquina pela primeira vez, leia as “INSTRUÇÕES DE SEGURANÇA IMPORTANTES” no Manual de Operações.

Consulte o Manual de Operações para obter instruções detalhadas.

Neste manual, as telas em inglês são usadas para as explicações básicas.

Bevor Sie die Maschine zum ersten Mal verwenden, lesen Sie bitte „WICHTIGE SICHERHEITSHINWEISE“ in der Bedienungsanleitung.

Ausführliche Hinweise finden Sie in der Bedienungsanleitung. In dieser Anleitung werden für die grundlegenden Erläuterungen englischsprachige Bildschirme verwendet.

Lees – voordat u de machine de eerste keer gebruikt – de “BELANGRIJKE VEILIGHEIDSINSTRUCTIES” in de Bedieningshandleiding.

In de Bedieningshandleiding vindt u uitvoerige aanwijzingen. In deze gids worden Engelse schermen gebruikt bij de uitleg van basisbewerkingen.

Antes de utilizar la máquina por primera vez, lea las “INSTRUCCIONES DE SEGURIDAD IMPORTANTES” en el Manual de instrucciones.

Consulte las instrucciones detalladas en el Manual de instrucciones.

En esta guía, para las explicaciones básicas se utilizan pantallas en inglés.

Перед первым использованием машины прочитайте раздел “ВАЖНЫЕ ИНСТРУКЦИИ ПО БЕЗОПАСНОСТИ” в Руководстве пользователя.

Подробные инструкции см. в Руководстве пользователя.

В данном руководстве в качестве иллюстраций используются англоязычные экраны.

Operation Manual Notations

Descriptions in the Operation Manual are divided into those for Model 1, 2, 3 or 4, depending on the machine specifications. For this sewing machine, refer to descriptions for Model 1.

Anmerkungen in der Bedienungsanleitung

Die Beschreibungen in der Bedienungsanleitung sind entsprechend den technischen Daten einer Maschine für Modell 1, 2, 3 oder 4 aufgeteilt. Für diese Nähmaschine gelten die Beschreibungen für Modell 1.

Remarques concernant le Manuel d'instructions

Les descriptions du Manuel d'instructions sont réparties entre les modèles 1, 2, 3 et 4, selon les caractéristiques de la machine. Pour cette machine à coudre, reportez-vous aux descriptions du modèle 1.

Opmerkingen Bedieningshandleiding

De beschrijvingen in de Bedieningshandleiding zijn opgesplitst voor de modellen 1, 2, 3 of 4, afhankelijk van de specificaties van de machines. Voor deze naaimachine zijn de beschrijvingen voor model 1 van toepassing.

Note nel Manuale di istruzioni

Le descrizioni riportate nel Manuale di istruzioni sono divise per modello (Modello 1, 2, 3 o 4), a seconda delle specifiche della macchina. Per questa macchina per cucire, consultare le descrizioni per il Modello 1.

Indicaciones del Manual de instrucciones

Las explicaciones del Manual de instrucciones aparecen divididas en base a los Modelos 1, 2, 3 o 4, dependiendo de las especificaciones de la máquina. Para esta máquina de coser, consulte las descripciones para el Modelo 1.

Notações no Manual de Operações

As descrições no Manual de Operações são divididas em descrições para os Modelos 1, 2, 3 ou 4, dependendo das especificações da máquina. Para esta máquina de costura, consulte as descrições para o Modelo 1.

Обозначения в Руководстве пользователя

Описания в Руководстве пользователя приведены для нескольких моделей машины. Они обозначены как инструкции для модели 1, 2, 3 или 4. К данной швейной машине относятся описания для модели 1.

Contents

Accessories	4
◆ Included Accessories	4
◆ Optional Accessories	4
Bobbin Winding and Setting	12
Upper Threading	14
Selecting and Sewing Patterns	16
◆ Preset Utility Stitches	16
◆ Utility Stitches	17
◆ Decorative Stitches	18
◆ Character stitches	18
Summary of Stitch Patterns	19
◆ Preset Utility Stitches	19
◆ Utility Stitches	19
◆ Decorative Stitches	19
◆ Character stitches	21

Inhalt

Zubehör	4
◆ Mitgeliefertes Zubehör	4
◆ Optionales Zubehör	4
Aufspulen des Unterfadens und Einstellung	12
Einfädeln des Oberfadens	14
Auswählen und Nähen von Stichen	16
◆ Voreingestellte Nutztische	16
◆ Nutztische	17
◆ Dekorstiche	18
◆ Buchstabenstiche.....	18
Stich-Übersicht	19
◆ Voreingestellte Nutztische	19
◆ Nutztische	19
◆ Dekorstiche	19
◆ Buchstabenstiche.....	21

Table des matières

Accessoires	6
◆ Accessoires inclus	6
◆ Accessoires en option	6
Bobinage et réglage de la canette	12
Enfilage supérieur	14
Sélection et couture de motifs	16
◆ Préréglage des points de couture courants	16
◆ Points de couture courants	17
◆ Points décoratifs	18
◆ Points de caractères.....	18
Sommaire des motifs de point	19
◆ Préréglage des points de couture courants	19
◆ Points de couture courants	19
◆ Points décoratifs	19
◆ Points de caractères.....	21

Inhoudsopgave

Accessoires	6
◆ Bijgeleverde accessoires	6
◆ Optionele accessoires.....	6
Opwinden en instellen van de spoel	12
Inrijgen van de bovendraad	14
Steken selecteren en naaien	16
◆ Vooraf ingestelde naaisteken	16
◆ Naaisteken	17
◆ Decoratieve steken	18
◆ Lettersteken	18
Steken overzicht	19
◆ Vooraf ingestelde naaisteken	19
◆ Naaisteken	19
◆ Decoratieve steken	19
◆ Lettersteken	21

Sommario

Accessori	8
◆ Accessori in dotazione	8
◆ Accessori opzionali	8
Avvolgimento spolina e caricamento	12
Infilatura superiore	14
Selezione e cucitura di motivi	16
◆ Punti utili preimpostati	16
◆ Punti utili	17
◆ Punti decorativi	18
◆ Punti a caratteri	18
Sommario degli schemi punto	19
◆ Punti utili preimpostati	19
◆ Punti utili	19
◆ Punti decorativi	19
◆ Punti a caratteri	21

Contenido

Accesorios	8
◆ Accesorios incluidos	8
◆ Accesorios opcionales	8
Bobinado y ajuste	12
Hilo superior	14
Seleccionar y coser patrones	16
◆ Puntadas de utilidad predefinidas	16
◆ Puntadas de utilidad	17
◆ Puntadas decorativas	18
◆ Puntadas de carácter	18
Resumen de tipos de puntada	19
◆ Puntadas de utilidad predefinidas	19
◆ Puntadas de utilidad	19
◆ Puntadas decorativas	19
◆ Puntadas de carácter	21

Índice

Acessórios	10
◆ Acessórios incluídos	10
◆ Acessórios opcionais	10
Configuração e enrolamento da bobina	12
Passagem da linha superior	14
Seleção e costura de padrões	16
◆ Pontos utilitários predefinidos	16
◆ Pontos utilitários	17
◆ Pontos decorativos	18
◆ Pontos de caracteres	18
Resumo dos padrões de ponto	19
◆ Pontos utilitários predefinidos	19
◆ Pontos utilitários	19
◆ Pontos decorativos	19
◆ Pontos de caracteres	21

Содержание

Принадлежности	10
◆ Принадлежности в комплекте поставки	10
◆ Дополнительные принадлежности	10
Намотка и установка шпульки	12
Заправка верхней нити	14
Выбор швейных строчек	16
◆ Предварительно заданные основные строчки	16
◆ Основные строчки	17
◆ Декоративные строчки	18
◆ Символьные строчки	18
Рисунки строчек	19
◆ Предварительно заданные основные строчки	19
◆ Основные строчки	19
◆ Декоративные строчки	19
◆ Символьные строчки	21

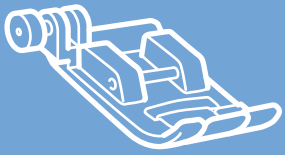

Accessories

Zubehör

◆ Included Accessories ◆ Mitgeliefertes Zubehör

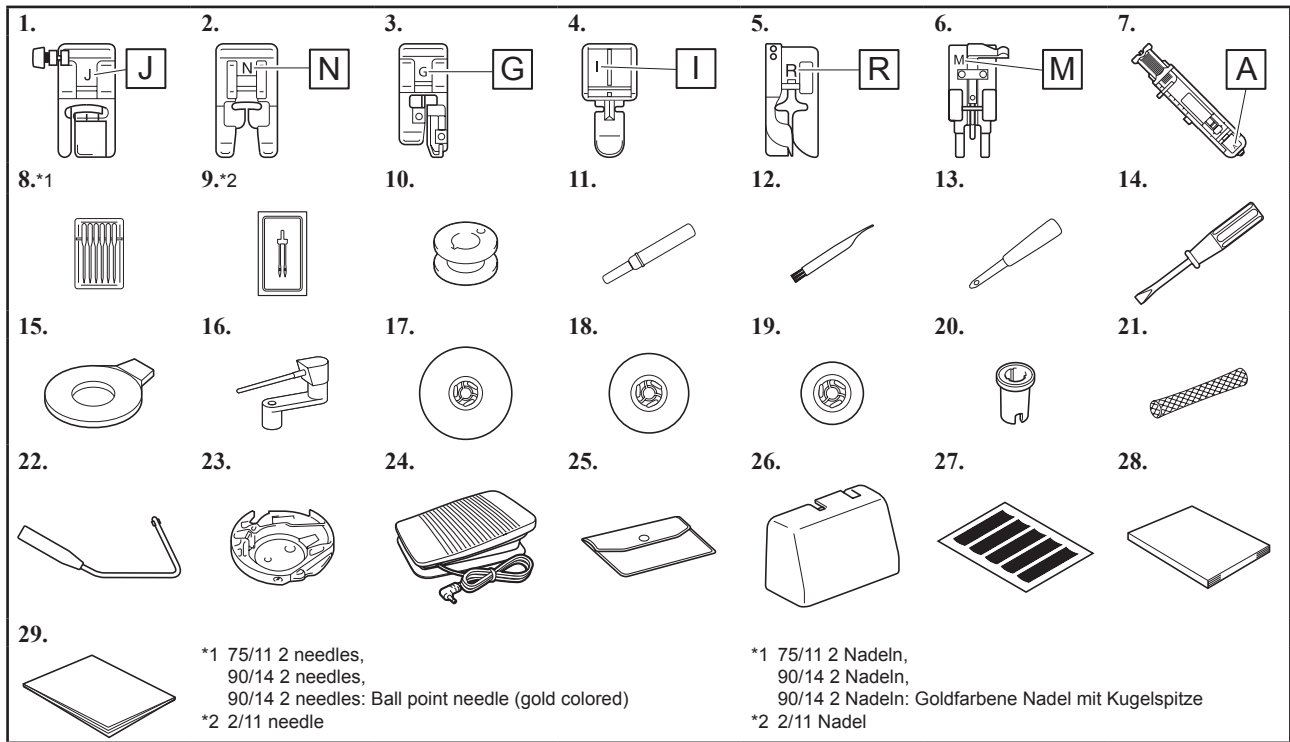

◆ Optional Accessories ◆ Optionales Zubehör

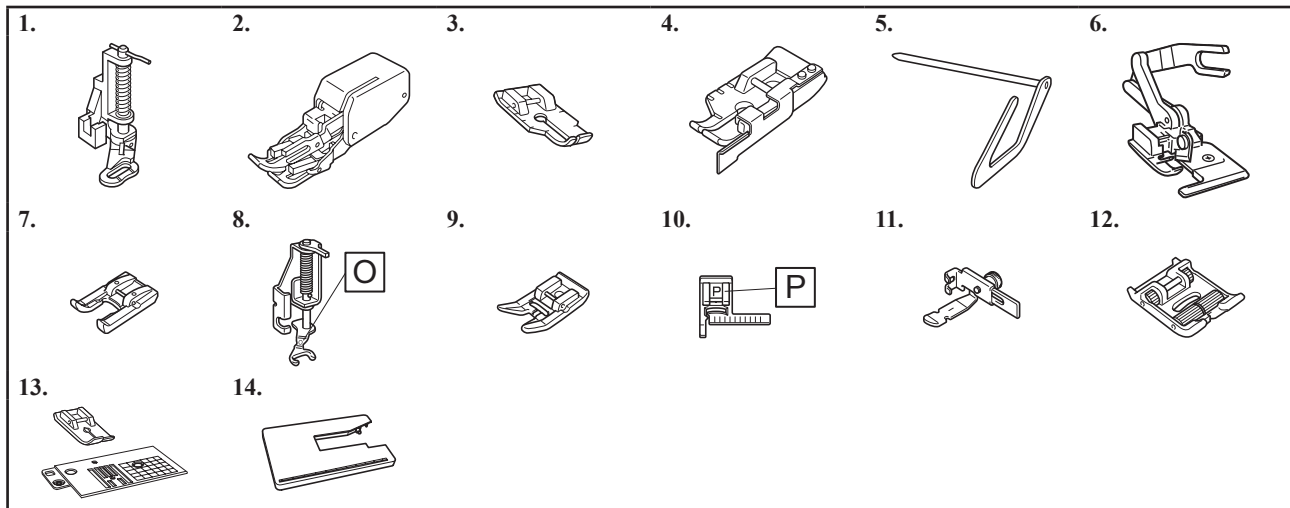

Note

- The presser foot holder screw is available through your authorized Brother dealer. (Part code: XG1343-001)
- The presser foot accessory tray is available, through your authorized Brother dealer. (Part code: XF8650-001)



Hinweis

- Die Nähfußhalterschraube ist bei Ihrem Fachhändler erhältlich. (Teilenummer: XG1343-001)
- Das Nähfußhalter-Zubehörtblett ist bei Ihrem Brother-Vertragshändler erhältlich. (Teilenummer: XF8650-001)

◆ Included Accessories

No.	Part Name	Part Code	
		Americas	Others
1	Zigzag foot "J" (on machine)		XF3022-001
2	Monogramming foot "N"		XD0810-031
3	Overcasting foot "G"		XC3098-031
4	Zipper foot "I"		X59370-021
5	Blind stitch foot "R"		XE2650-001
6	Button fitting foot "M"		XE2643-001
7	Buttonhole foot "A"		XC2691-023
8	Needle set		X58358-021
9	Twin needle		X59296-121
10	Bobbin (4) (One is on machine.)	SA156*3	SFB: XA5539-151
11	Seam ripper		XF4967-001
12	Cleaning brush		X59476-051
13	Eyelet punch		XZ5051-001
14	Screwdriver		XC8349-021
15	Disc-shaped screwdriver		XC1074-051
16	Horizontal spool pin		XC4654-251
17	Spool cap (large)		130012-024
18	Spool cap (medium) (2) (One is on machine.)		XE1372-001
19	Spool cap (small)		130013-124
20	Thread spool insert (mini king thread spool)		XA5752-121
21	Spool net		XA5523-020
22	Knee lifter		XA6941-052
23	Bobbin case (on machine)		XG2058-001
24	Foot controller		XZ5098-001(EU area) XZ5100-001(other areas)
25	Accessory bag		XC4487-021
26	Hard case		XG5628-001
27	Grid sheet set		XC4549-020
28	Operation Manual		Contact your authorized Brother dealer.
29	Quick Reference Guide		Contact your authorized Brother dealer.

*3 SA156 is Class15 type bobbin.

◆ Mitgeliefertes Zubehör

Nr.	Teilebezeichnung	Bestellnummer	
		Nord- und Südamerika	Andere
1	Zickzackfuß „J“ (an der Maschine)		XF3022-001
2	Nähfuß „N“		XD0810-031
3	Überwendlingfuß „G“		XC3098-031
4	Reißverschlussfuß „I“		X59370-021
5	Blindstichfuß „R“		XE2650-001
6	Knopfannähfuß „M“		XE2643-001
7	Knopflochfuß „A“		XC2691-023
8	Nadelsatz		X58358-021
9	Zwillingsnadel		X59296-121
10	Spule (4) (Eine ist in der Maschine.)	SA156*3	SFB: XA5539-151
11	Pfeiltrenner		XF4967-001
12	Reinigungspinsel		X59476-051
13	Ahle		XZ5051-001
14	Schraubendreher		XC8349-021
15	Scheibenförmiger Schraubendreher		XC1074-051
16	Horizontaler Garnrollenstift		XC4654-251
17	Garnrollenkappe (groß)		130012-024
18	Garnrollenkappe (mittel) (2) (Eine ist in der Maschine.)		XE1372-001
19	Garnrollenkappe (klein)		130013-124
20	Garnrollenkappeneinsatz (Mini King Garnrolle)		XA5752-121
21	Spulennetz		XA5523-020
22	Kniehebel		XA6941-052
23	Spulenkapsel (in der Maschine)		XG2058-001
24	Fußpedal		XZ5098-001(EU-Zone) XZ5100-001(Andere Zonen)
25	Zubehörtasche		XC4487-021
26	Tragekoffer		XG5628-001
27	Schabloneinsatz		XC4549-020
28	Bedienungsanleitung		Wenden Sie sich an Ihr Brother-Fachgeschäft.
29	Kurzanleitung		Wenden Sie sich an Ihr Brother-Fachgeschäft.

*3 SA156 ist eine Class15-Spule.

◆ Optional Accessories

The following are available as optional accessories to be purchased separately from your authorized Brother dealer.

No.	Part Name	Part Code	
		Americas	Others
1	Quilting foot	SA129	F005N: XC1948-052
2	Walking foot	SA140	F033N: XC2214-052
3	1/4" quilting foot	SA125	F001N: XC1944-052
4	1/4" quilting foot with guide	SA185	F057: XC7416-252
5	Quilting guide	SA132	F016N: XC2215-052
6	Side cutter "S"	SA177	F054: XC3879-152
7	Open toe foot	SA186	F060: XE1094-101
8	Free motion open toe quilting foot "O"	SA187	F061: XE1097-001
9	Non stick foot	SA114	F007N: XC1949-052
10	Stitch guide foot "P"	SA160	F035N: XC1969-052
11	Adjustable zipper/piping foot	SA161	F036N: XC1970-052
12	Roller foot	SA190	F066: XF1723-001
13	Straight stitch foot and needle plate set	SA564 SA564C (Canada)	SNP02: XG0946-001 SNP02AP: XG0948-001
14	Wide table	SAWT4	WT14: XG5051-001 WT14AP: XG4656-001

◆ Optionales Zubehör

Folgendes Sonderzubehör ist separat bei Ihrem Brother-Vertragshändler erhältlich.

Nr.	Teilebezeichnung	Bestellnummer	
		Nord- und Südamerika	Andere
1	Freihand Stick- und Quiltfuß	SA129	F005N: XC1948-052
2	Stoffobertransport	SA140	F033N: XC2214-052
3	1/4-Zoll-Quiltfuß	SA125	F001N: XC1944-052
4	1/4-Zoll-Quiltfuß mit Führung	SA185	F057: XC7416-252
5	Quilt-Führung	SA132	F016N: XC2215-052
6	Kantenabschneider „S“	SA177	F054: XC3879-152
7	Applikationsfuß	SA186	F060: XE1094-101
8	Offener Freihand Quiltingfuß „O“	SA187	F061: XE1097-001
9	Antihafffuß	SA114	F007N: XC1949-052
10	Stichführungsfuß „P“	SA160	F035N: XC1969-052
11	Einstellbarer Reißverschluss/Kordelfuß	SA161	F036N: XC1970-052
12	Rollenfuß	SA190	F066: XF1723-001
13	Geradstichfuß und Geradstichplatte	SA564 SA564C (Kanada)	SNP02: XG0946-001 SNP02AP: XG0948-001
14	Maxi-Anschiebetisch	SAWT4	WT14: XG5051-001 WT14AP: XG4656-001

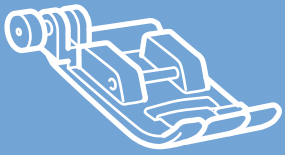

Accessoires

Accessoires

◆ Accessoires inclus

◆ Bijgeleverde accessoires

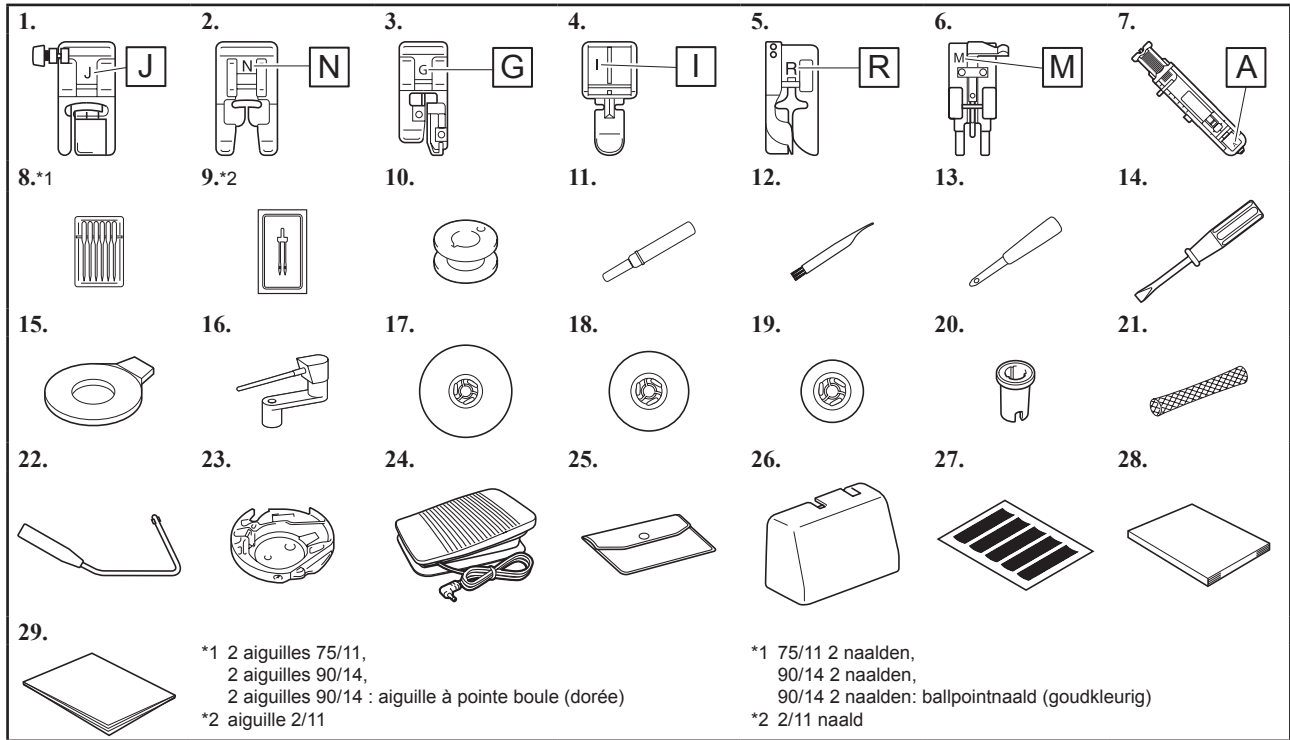

◆ Accessoires en option ◆ Optionele accessoires

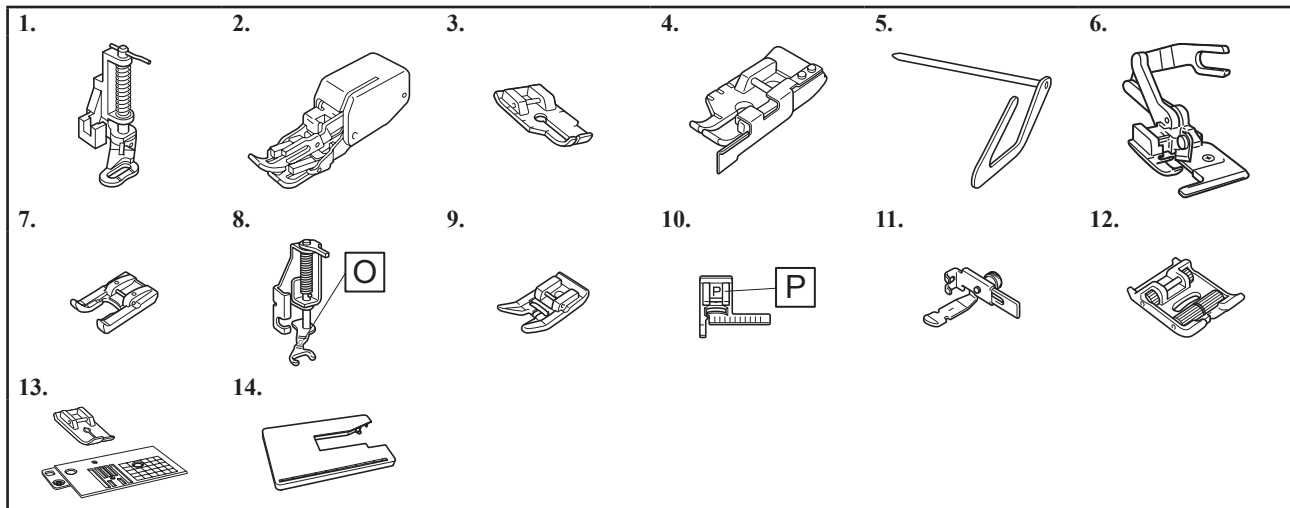

Remarque

- La vis du support du pied-de-biche est disponible auprès de votre revendeur Brother agréé. (code de référence: XG1343-001)
- Le tiroir d'accessoires pour pied-de-biche est disponible auprès de votre revendeur Brother agréé. (code de référence: XF8650-001)



Opmerking

- De persvoethouderschroef is verkrijgbaar via uw erkende Brother-dealer. (onderdeelcode: XG1343-001)
- Het opbergvak voor persvoeten is verkrijgbaar via uw erkende Brother-dealer. (onderdeelcode: XF8650-001)

◆ Accessoires inclus

N°	Nom de la pièce	Code de la pièce	
		Continent américain	Autres
1	Pied zigzag « J » (sur la machine)		XF3022-001
2	Pied pour monogrammes « N »		XD0810-031
3	Pied pour faufilage « G »		XC3098-031
4	Pied pour fermetures à glissière « I »		X59370-021
5	Pied pour point invisible « R »		XE2650-001
6	Pied pour boutons « M »		XE2643-001
7	Pied pour boutonnières « A »		XC2691-023
8	Jeu d'aiguilles		X58358-021
9	Aiguille jumelée		X59296-121
10	Canette (4) (L'une se trouve sur la machine.)	SA156*3	SFB: XA5539-151
11	Découpeur		XF4967-001
12	Brosse de nettoyage		X59476-051
13	Perce-œillet		XZ5051-001
14	Tournevis		XC8349-021
15	Tournevis en forme de disque		XC1074-051
16	Porte-bobine horizontal		XC4654-251
17	Couvercle de bobine (grand)		130012-024
18	Couvercle de bobine (moyen) x 2 (L'un se trouve sur la machine.)		XE1372-001
19	Couvercle de bobine (petit)		130013-124
20	Centre amovible pour bobine de fil (bobine de fil mini/très grande)		XA5752-121
21	Filet de la bobine		XA5523-020
22	Genouillère		XA6941-052
23	Boîtier de la canette (sur la machine)		XG2058-001
24	Pédale		XZ5098-001 (zone UE) XZ5100-001 (autres zones)
25	Sac d'accessoires		XC4487-021
26	Protection rigide		XG5628-001
27	Ensemble de feuilles quadrillées		XC4549-020
28	Manuel d'instructions		Contactez votre revendeur
29	Guide de référence rapide		Brother agréé.

*3 SA156 est une canette de catégorie 15.

◆ Bijgeleverde accessoires

Nr.	Onderdeel	Onderdeelcode	
		Het Amerikaanse continent	Overige regio's
1	Zigzagvoet "J" (op machine)		XF3022-001
2	Monogramvoet "N"		XD0810-031
3	Afwerksteekvoet "G"		XC3098-031
4	Ritsvoet "I"		X59370-021
5	Blindzoomvoet "R"		XE2650-001
6	Knoopaanzetvoet "M"		XE2643-001
7	Knoopsgatvoet "A"		XC2691-023
8	Naaldsetje		X58358-021
9	Tweelingnaald		X59296-121
10	Spoel x 4 (één spoel is in de machine geplaatst.)	SA156*3	SFB: XA5539-151
11	Tommesje		XF4967-001
12	Schoonmaakborsteltje		X59476-051
13	Gaatjesponser		XZ5051-001
14	Schroevendraaier		XC8349-021
15	Schijfvormige schroevendraaier		XC1074-051
16	Horizontale klossen		XC4654-251
17	Kloshouder (groot)		130012-024
18	Kloshouder (medium) x 2 (één spoel is in de machine geplaatst.)		XE1372-001
19	Kloshouder (klein)		130013-124
20	Garenklos hulpinzet (bij mini- of kingsize garenklos)		XA5752-121
21	Klosnetje		XA5523-020
22	Kniehevel		XA6941-052
23	Spoelhuis (op de machine geplaatst)		XG2058-001
24	Voetpedaal		XZ5098-001 (EU) XZ5100-001 (andere regio's)
25	Accessoires tasje		XC4487-021
26	Koffer		XG5628-001
27	Rasterzet		XC4549-020
28	Bedieningshandleiding		Neem contact op met uw erkende
29	Beknopte bedieningshandleiding		Brother-dealer.

*3 SA156 is een spoeltype van klasse 15.

◆ Accessoires en option

Les éléments suivants sont des accessoires en option vendus séparément par votre revendeur Brother agréé.

N°	Nom de la pièce	Code de la pièce	
		Continent américain	Autres
1	Pied pour quilting (courtepointe)	SA129	F005N: XC1948-052
2	Pied à double entraînement	SA140	F033N: XC2214-052
3	Pied pour quilting (courtepointe) 1/4" / pouce	SA125	F001N: XC1944-052
4	Guide et pied pour quilting (courtepointe) 1/4" / pouce	SA185	F057: XC7416-252
5	Guide pour quilting (courtepointe)	SA132	F016N: XC2215-052
6	Couteau raseur « S »	SA177	F054: XC3879-152
7	Pied ouvert	SA186	F060: XE1094-101
8	Pied pour quilting (courtepointe) ouvert en mouvement libre « O »	SA187	F061: XE1097-001
9	Pied-de-biche non adhérent	SA114	F007N: XC1949-052
10	Pied-de-biche de guidage de points « P »	SA160	F035N: XC1969-052
11	Pied réglable pour fermetures à glissière/passepoils	SA161	F036N: XC1970-052
12	Pied à rouleau	SA190	F066: XF1723-001
13	Ensemble pied pour point droit et plaque d'aiguille	SA564 SA564C (Canada)	SNP02: XG0946-001 SNP02AP: XG0948-001
14	Grande table d'extension	SAWT4	WT14: XG5051-001 WT14AP: XG4656-001

◆ Optionele accessoires

Optionele accessoires, apart verkrijgbaar bij uw officiële Brother dealer.

Nr.	Onderdeel	Onderdeelcode	
		Het Amerikaanse continent	Overige regio's
1	Quiltvoet	SA129	F005N: XC1948-052
2	Boventransportvoet	SA140	F033N: XC2214-052
3	1/4-inch quiltvoet	SA125	F001N: XC1944-052
4	1/4-inch quiltvoet met geleider	SA185	F057: XC7416-252
5	Quiltgeleider	SA132	F016N: XC2215-052
6	Zijnsnijder "S"	SA177	F054: XC3879-152
7	Open voet	SA186	F060: XE1094-101
8	Open quiltvoet "O" voor naaien uit de vrije hand	SA187	F061: XE1097-001
9	Gladde transportvoet	SA114	F007N: XC1949-052
10	Steekgeleidervoet "P"	SA160	F035N: XC1969-052
11	Verstelbare ritsvoet / paspelvoet	SA161	F036N: XC1970-052
12	Rolvoet	SA190	F066: XF1723-001
13	Rechte-steekvoet en naaldplaatset	SA564 SA564C (Canada)	SNP02: XG0946-001 SNP02AP: XG0948-001
14	Groot werkblad	SAWT4	WT14: XG5051-001 WT14AP: XG4656-001

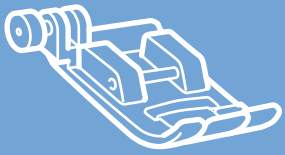

Accessori

Accesorios

◆ Accessori in dotazione ◆ Accesorios incluidos

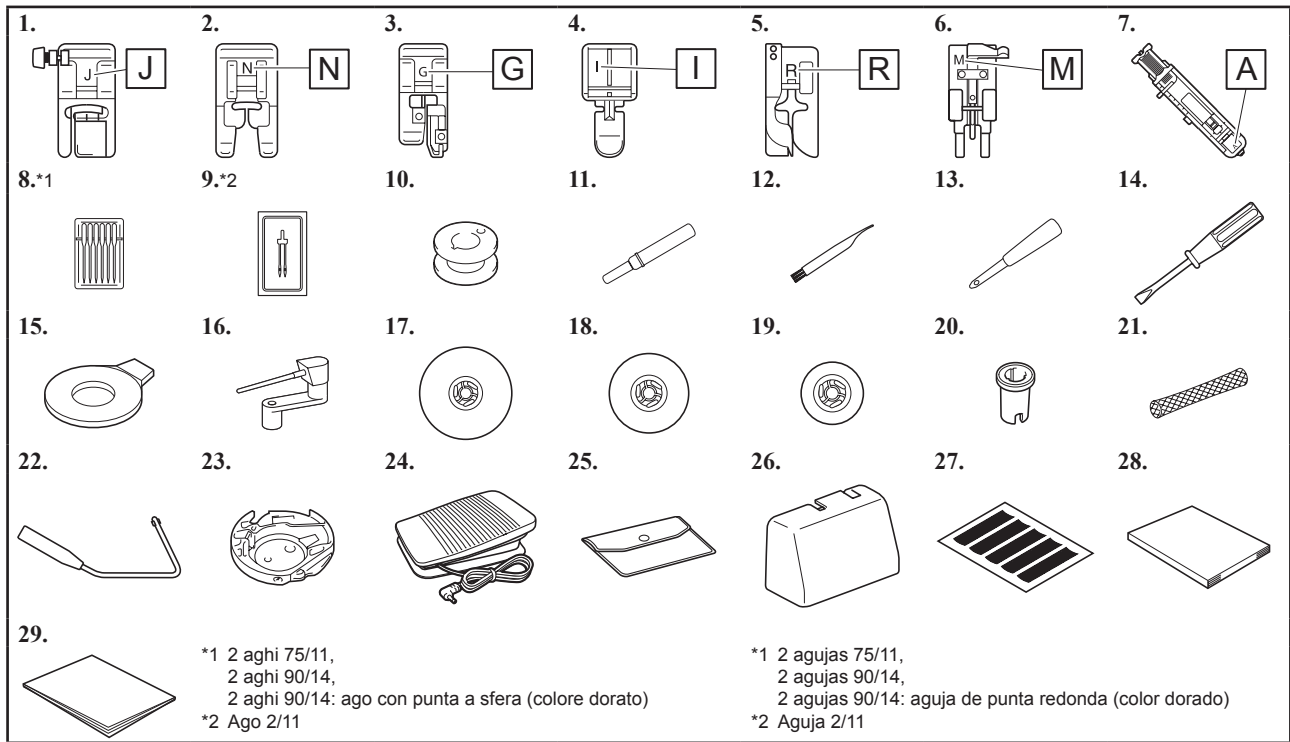

◆ Accessori opzionali ◆ Accesorios opcionales

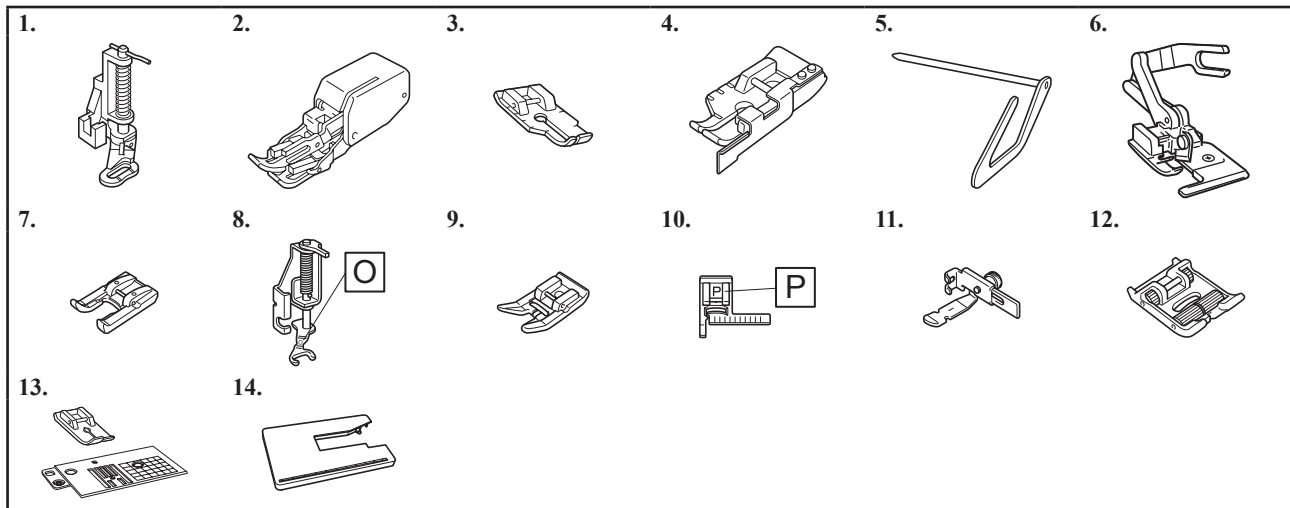

Nota

- La vite del supporto del piedino premistoffa è disponibile presso il proprio rivenditore Brother autorizzato. (Codice parte: XG1343-001)
- Il vano accessori per piedini premistoffa è disponibile presso il proprio rivenditore Brother autorizzato. (Codice parte: XF8650-001)



Nota

- Puede adquirir el tornillo del soporte del pie prensatela en su distribuidor autorizado Brother. (Referencia: XG1343-001)
- Puede adquirir la bandeja de accesorios del pie prensatela en su distribuidor Brother autorizado. (Referencia: XF8650-001)

◆ Accessori in dotazione

N°	Nome parte	Codice parte	
		Americhe	Varie
1	Piedino per zig-zag "J" (sulla macchina)		XF3022-001
2	Piedino per monogrammi "N"		XD0810-031
3	Piedino per soprappiglio "G"		XC3098-031
4	Piedino per cerniere "I"		X59370-021
5	Piedino per punto invisibile "R"		XE2650-001
6	Piedino di cucitura bottone "M"		XE2643-001
7	Piedino per asole "A"		XC2691-023
8	Set di aghi		X58358-021
9	Ago gemello		X59296-121
10	Spolina (4) (una è sulla macchina.)	SA156*3	SFB: XA5539-151
11	Taglia asole		XF4967-001
12	Spazzolino di pulizia		X59476-051
13	Punzone per occhielli		XZ5051-001
14	Cacciavite		XC8349-021
15	Cacciavite a disco		XC1074-051
16	Portarocchetto orizzontale		XC4654-251
17	Fermo per rocchetto (grande)		130012-024
18	Fermo per rocchetto (medio) (2) (uno è sulla macchina.)		XE1372-001
19	Fermo per rocchetto (piccolo)		130013-124
20	Inserito per rocchetto di filo (rocchetto di filo mini-extra large)		XA5752-121
21	Retina		XA5523-020
22	Ginocchiera alzapiedino		XA6941-052
23	Cestello della spolina (sulla macchina)		XG2058-001
24	Pedale reostato	XZ5098-001 (area UE) XZ5100-001 (altre aree)	
25	Borsa accessori		XC4487-021
26	Custodia rigida		XG5628-001
27	Set di fogli millimetrati		XC4549-020
28	Manuale di istruzioni		Contattare il proprio rivenditore Brother autorizzato.
29	Guida di riferimento rapido		Contattare il proprio rivenditore Brother autorizzato.

*3 SA156 è una spolina del tipo Classe 15.

◆ Accesorios incluidos

N°	Nombre de la pieza	Código de la pieza	
		América	Otros
1	Pie para zig-zag "J" (en la máquina)		XF3022-001
2	Pie para monogramas "N"		XD0810-031
3	Pie para sobrehilado "G"		XC3098-031
4	Pie para cremalleras "I"		X59370-021
5	Pie para puntada invisible "R"		XE2650-001
6	Pie especial para botones "M"		XE2643-001
7	Pie para ojales "A"		XC2691-023
8	Juego de agujas		X58358-021
9	Aguja gemela		X59296-121
10	Bobina (4) (Una está colocada en la máquina.)	SA156*3	SFB: XA5539-151
11	Abreojales		XF4967-001
12	Cepillo de limpieza		X59476-051
13	Lápiz calador		XZ5051-001
14	Destornillador		XC8349-021
15	Destornillador de disco		XC1074-051
16	Portacarrete horizontal		XC4654-251
17	Tapa del carrete (grande)		130012-024
18	Tapa del carrete (mediana) (2) (Una está colocada en la máquina.)		XE1372-001
19	Tapa de carrete (pequeña)		130013-124
20	Inserción del carrete de hilo (carrete de hilo "mini king")		XA5752-121
21	Red para carrete		XA5523-020
22	Elevador de rodilla		XA6941-052
23	Caja de la bobina (en la máquina)		XG2058-001
24	Pedal	XZ5098-001 (zona de la UE) XZ5100-001 (otras zonas)	
25	Bolsa de accesorios		XC4487-021
26	Estuche protector		XG5628-001
27	Juego de hojas cuadrículadas		XC4549-020
28	Manual de instrucciones		Póngase en contacto con su distribuidor Brother autorizado.
29	Guía de referencia rápida		Póngase en contacto con su distribuidor Brother autorizado.

*3 SA156 Es de bobina clase tipo 15.

◆ Accessori opzionali

Di seguito si elencano i componenti disponibili come accessori opzionali da acquistare separatamente presso il proprio rivenditore Brother autorizzato.

N°	Nome parte	Codice parte	
		Americhe	Varie
1	Piedino per trapuntatura	SA129	F005N: XC1948-052
2	Piedino doppio trasporto	SA140	F033N: XC2214-052
3	Piedino per trapuntatura da 1/4"	SA125	F001N: XC1944-052
4	Piedino per trapuntatura da 1/4" con guida	SA185	F057: XC7416-252
5	Guida per trapuntatura	SA132	F016N: XC2215-052
6	Taglierina laterale "S"	SA177	F054: XC3879-152
7	Piedino a punta aperta	SA186	F060: XE1094-101
8	Piedino a punta aperta per trapuntatura a mano libera "O"	SA187	F061: XE1097-001
9	Piedino antiaderente	SA114	F007N: XC1949-052
10	Piedino guida punto "P"	SA160	F035N: XC1969-052
11	Piedino regolabile per cerniere/cordoncino	SA161	F036N: XC1970-052
12	Piedino a rullo	SA190	F066: XF1723-001
13	Set piedino e placca ago per punto diritto	SA564 SA564C (Canada)	SNP02: XG0946-001 SNP02AP: XG0948-001
14	Tavola ampia	SAWT4	WT14: XG5051-001 WT14AP: XG4656-001

◆ Accesorios opcionales

En la tabla siguiente se presentan los accesorios opcionales disponibles que pueden adquirirse por separado en un distribuidor de Brother autorizado.

N°	Nombre de la pieza	Código de la pieza	
		América	Otros
1	Pie para acolchados	SA129	F005N: XC1948-052
2	Pie móvil	SA140	F033N: XC2214-052
3	Pie para acolchado de 1/4"	SA125	F001N: XC1944-052
4	Pie para acolchado de 1/4" con guía	SA185	F057: XC7416-252
5	Guía de acolchados	SA132	F016N: XC2215-052
6	Cuchilla lateral "S"	SA177	F054: XC3879-152
7	Pie de punta abierta	SA186	F060: XE1094-101
8	Pie para acolchado libre de punta abierta "O"	SA187	F061: XE1097-001
9	Pie antiaderente	SA114	F007N: XC1949-052
10	Pie para guía de puntadas "P"	SA160	F035N: XC1969-052
11	Pie ajustable para cremalleras/ribetes	SA161	F036N: XC1970-052
12	Pie de rodillo	SA190	F066: XF1723-001
13	Pie de costura recta y juego de placas de la aguja	SA564 SA564C (Canada)	SNP02: XG0946-001 SNP02AP: XG0948-001
14	Tabla ancha	SAWT4	WT14: XG5051-001 WT14AP: XG4656-001

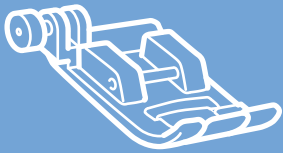

Acessórios

Принадлежности

◆ Acessórios incluídos ◆ Принадлежности в комплекте поставки

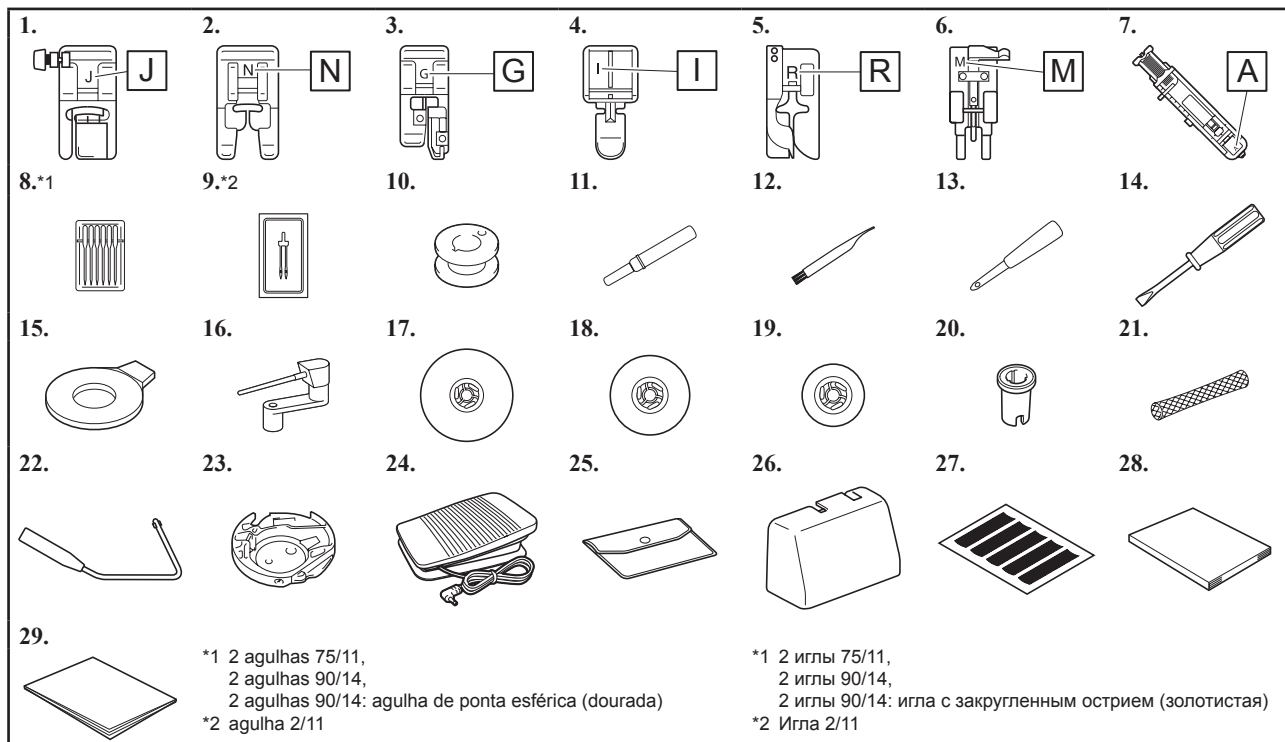

◆ Acessórios opcionais ◆ Дополнительные принадлежности

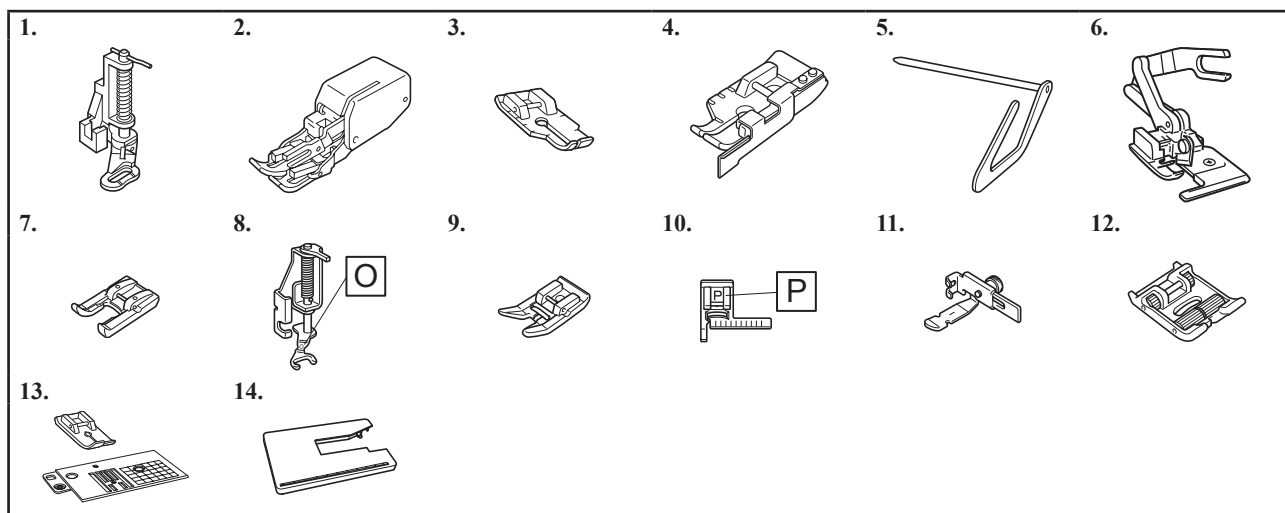

Nota

- O parafuso do suporte do pé-calçador está disponível com o seu revendedor autorizado da Brother. (Código da peça: XG1343-001)
- A bandeja acessória do pé-calçador está disponível com o seu revendedor autorizado da Brother. (Código da peça: XF8650-001)



Примечание

- Винт держателя прижимной лапки можно приобрести у официального дилера Brother. (номер по каталогу: XG1343-001)
- Ящик для прижимных лапок можно приобрести у официального дилера Brother. (номер по каталогу: XF8650-001).

◆ Acessórios incluídos

N°	Nome da peça	Código da peça	
		Américas	Outros
1	Calçador de zigue-zague "J" (na máquina)		XF3022-001
2	Calçador de monograma "N"		XD0810-031
3	Calçador de chuleado "G"		XC3098-031
4	Calçador de zíper "I"		X59370-021
5	Calçador de ponto invisível "R"		XE2650-001
6	Calçador de pregar de botão "M"		XE2643-001
7	Calçador de casear botão "A"		XC2691-023
8	Conjunto de agulhas		X58358-021
9	Agulha dupla		X59296-121
10	Bobina (4) (Uma está na máquina.)	SA156*3	SFB: XA5539-151
11	Abridor de costura		XF4967-001
12	Escova de limpeza		X59476-051
13	Perfurador de ilhó		XZ5051-001
14	Chave de fenda		XC8349-021
15	Chave de fenda em forma de disco		XC1074-051
16	Porta-carretel horizontal		XC4654-251
17	Tampa do carretel (grande)		130012-024
18	Tampa do carretel (média) (2) (Uma está na máquina.)		XE1372-001
19	Tampa do carretel (pequena)		130013-124
20	Inserto do carretel (minicarretel principal)		XA5752-121
21	Redinha do carretel		XA5523-020
22	Joelheira		XA6941-052
23	Caixa da bobina (na máquina)		XG2058-001
24	Pedal	XZ5098-001(Região da UE) XZ5100-001(outras regiões)	
25	Bolsa de acessórios		XC4487-021
26	Estojo rígido		XG5628-001
27	Conjunto de folhas de gabarito		XC4549-020
28	Manual de Operações	Entre em contato com o seu revendedor autorizado Brother.	
29	Guia de referência rápida		

*3 SA156 é um tipo de bobina da classe 15.

◆ Acessórios opcionais

Os acessórios a seguir são opcionais e devem ser adquiridos separadamente em um revendedor autorizado da Brother.

N°	Nome da peça	Código da peça	
		Américas	Outros
1	Calçador de acolchoado	SA129	F005N: XC1948-052
2	Calçador de transporte duplo	SA140	F033N: XC2214-052
3	Calçador de acolchoado 1/4"	SA125	F001N: XC1944-052
4	Calçador de acolchoado 1/4" com guia	SA185	F057: XC7416-252
5	Guia de acolchoado	SA132	F016N: XC2215-052
6	Cortador lateral em "S"	SA177	F054: XC3879-152
7	Calçador aberto	SA186	F060: XE1094-101
8	Calçador aberto de movimento livre para acolchoados "O"	SA187	F061: XE1097-001
9	Calçador antiaderente	SA114	F007N: XC1949-052
10	Calçador de guia de ponto "P"	SA160	F035N: XC1969-052
11	Calçador ajustável de zíper/vivo	SA161	F036N: XC1970-052
12	Calçador com rolete	SA190	F066: XF1723-001
13	Conjunto de calçador de ponto reto e chapa de agulha	SA564 SA564C (Canadá)	SNP02: XG0946-001 SNP02AP: XG0948-001
14	Mesa extensora	SAWT4	WT14: XG5051-001 WT14AP: XG4656-001

◆ Pertencimentos em conjunto de entrega

№	Наименование	Код изделия	
		Америка	Другие
1	Лапка для строчки зигзаг "J" (установлена на машине)		XF3022-001
2	Лапка для выстрачивания монограмм "N"		XD0810-031
3	Лапка для краеобметочных работ "G"		XC3098-031
4	Лапка для вшивания "молнии" "I"		X59370-021
5	Лапка для потайной строчки "R"		XE2650-001
6	Лапка для пришивания пуговиц "M"		XE2643-001
7	Лапка для обметывания петель "A"		XC2691-023
8	Набор игл		X58358-021
9	Двойная игла		X59296-121
10	Шпулька (4 шт.) (одна из них установлена на машине.)	SA156*3	SFB: XA5539-151
11	Вспарыватель для петель		XF4967-001
12	Щеточка для очистки		X59476-051
13	Прошивка		XZ5051-001
14	Отвертка		XC8349-021
15	Дискообразная отвертка		XC1074-051
16	Горизонтальный стержень для установки катушки		XC4654-251
17	Колпачок катушки (большой)		130012-024
18	Колпачок катушки (средний) (2 шт.) (один из них установлен на машине.)		XE1372-001
19	Колпачок катушки (малый)		130013-124
20	Вставка для катушки с нитью (катушки Mini-King)		XA5752-121
21	Сетка для катушки		XA5523-020
22	Коленоподъемник		XA6941-052
23	Шульный колпачок (установлен на машине)		XG2058-001
24	Педаль	XZ5098-001 (для ЕС), XZ5100-001 (другие регионы)	
25	Сумка для принадлежностей		XC4487-021
26	Жесткий футляр		XG5628-001
27	Комплект листов с координатной сеткой		XC4549-020
28	Руководство пользователя	Обратитесь к официальному дилеру Brother.	
29	Краткий справочник		

*3 SA156 представляет собой шпульку типа Class15.

◆ Дополнительные принадлежности

Перечисленные ниже дополнительные принадлежности можно приобрести отдельно у официального дилера Brother.

№	Наименование	Код изделия	
		Америка	Другие
1	Стегальная лапка	SA129	F005N: XC1948-052
2	Шагающая лапка	SA140	F033N: XC2214-052
3	Стегальная лапка 1/4 дюйма	SA125	F001N: XC1944-052
4	Стегальная лапка 1/4 дюйма с направляющей	SA185	F057: XC7416-252
5	Направляющая для выстигивания	SA132	F016N: XC2215-052
6	Боковой нож "S"	SA177	F054: XC3879-152
7	Лапка с открытым мыском	SA186	F060: XE1094-101
8	Стегальная лапка с открытым мыском "O" для свободной подачи материала	SA187	F061: XE1097-001
9	Скользкая лапка	SA114	F007N: XC1949-052
10	Направляющая лапка "P"	SA160	F035N: XC1969-052
11	Регулируемая лапка для вшивания молнии/канта	SA161	F036N: XC1970-052
12	Роликовая лапка	SA190	F066: XF1723-001
13	Игольная пластина и прижимная лапка для прямострочных операций	SA564 SA564C (для Канады)	SNP02: XG0946-001 SNP02AP: XG0948-001
14	Стол-приставка	SAWT4	WT14: XG5051-001 WT14AP: XG4656-001



Bobbin Winding and Setting

Aufspulen des Unterfadens und Einstellung

Bobinage et réglage de la canette

Opwinden en instellen van de spoel

Avvolgimento spolina e caricamento

Bobinado y ajuste

Configuração e enrolamento da bobina

Намотка и установка шпульки

Follow the steps below in numerical order. Refer to the Operation Manual for detailed instructions.
 Führen Sie die folgenden Schritte in der numerischen Reihenfolge aus. Ausführliche Hinweise finden Sie in der Bedienungsanleitung.
 Respectez les étapes ci-dessous, dans l'ordre numérique. Reportez-vous au Manuel d'instructions pour des informations détaillées.
 Volg onderstaande stappen in numerieke volgorde. In de Bedieningshandleiding vindt u uitvoerige aanwijzingen.
 Seguire i passaggi di seguito, in ordine numerico. Per le istruzioni dettagliate, consultare il Manuale di istruzioni.
 Siga los pasos descritos a continuación, en orden numérico. Consulte las instrucciones detalladas en el Manual de instrucciones.
 Siga as etapas abaixo, em ordem numérica. Consulte o Manual de Operações para obter instruções detalhadas.
 Выполните описанные ниже действия по порядку номеров. Подробные инструкции см. в Руководстве пользователя.

Use only the included bobbin or bobbins of the same type.
 Verwenden Sie nur die im Lieferumfang enthaltene Spule oder Spulen vom selben Typ.
 N'utilisez que la canette fournie ou des canettes du même type.
 Gebruik uitsluitend de bijgeleverde spoel of spoelen van hetzelfde type.
 Utilizzare solo la bobina o le bobine in dotazione dello stesso tipo.
 Utilice solo la bobina incluida, o bobinas del mismo tipo.
 Somente use a bobina incluída ou bobinas do mesmo tipo.
 Используйте только прилагаемые шпульки или шпульки того же типа.

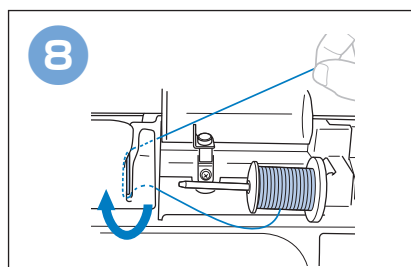
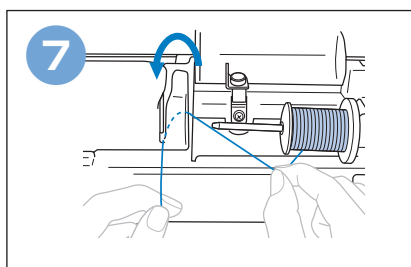
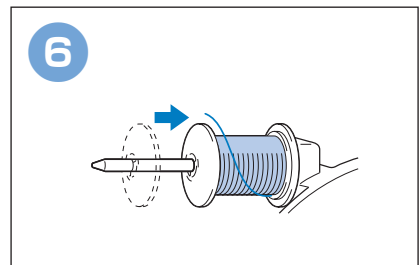
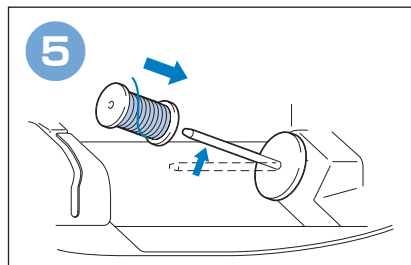
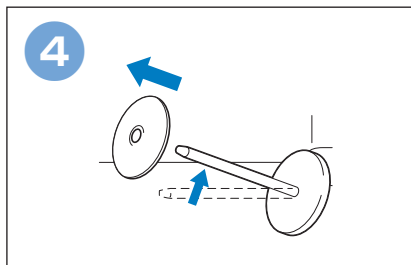
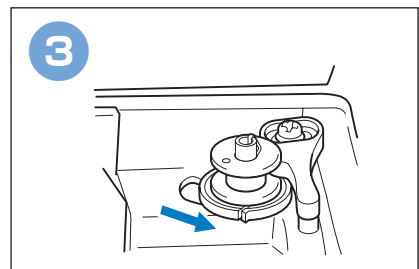
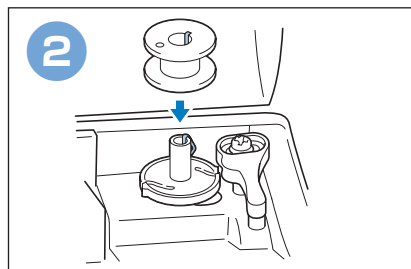
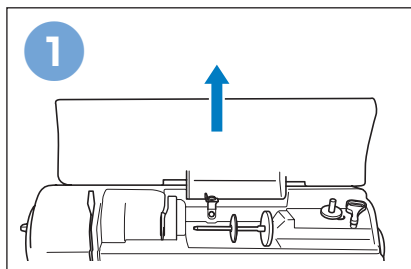
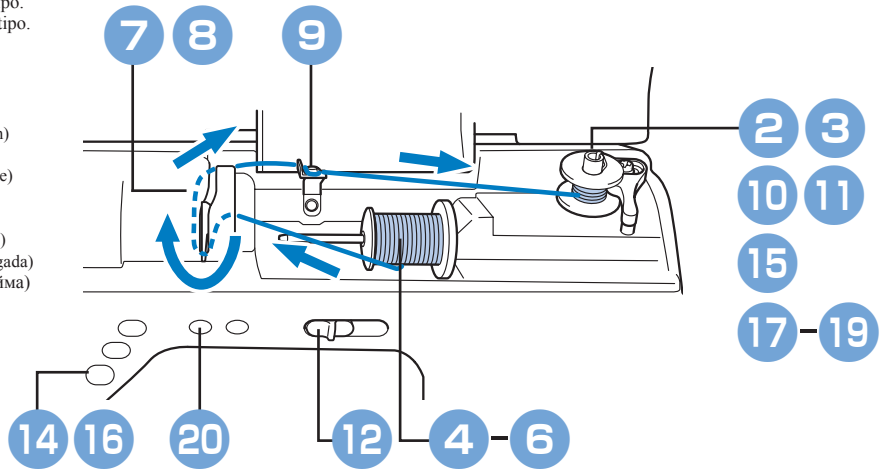
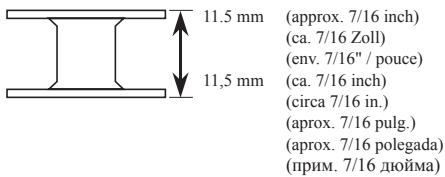

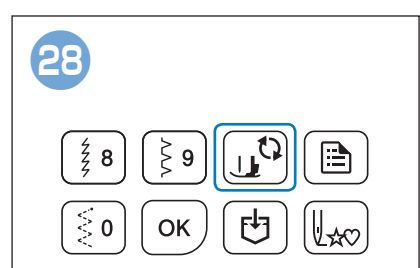
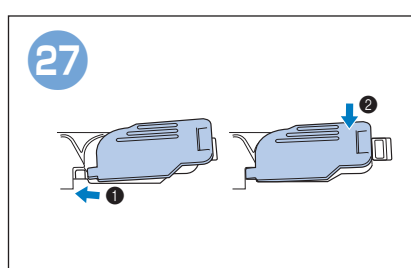
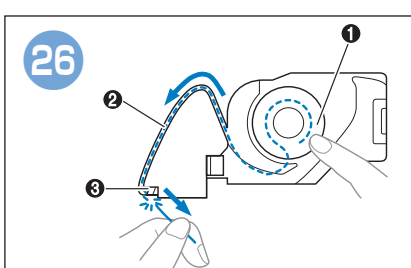
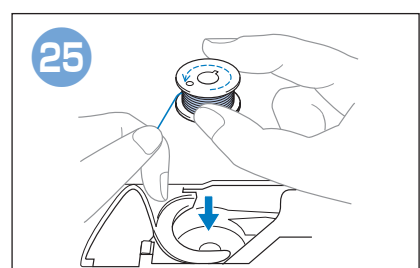
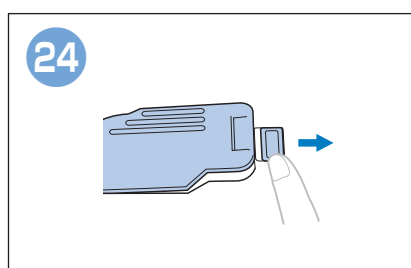
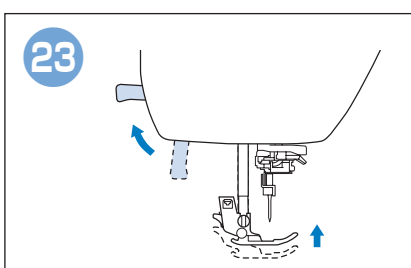
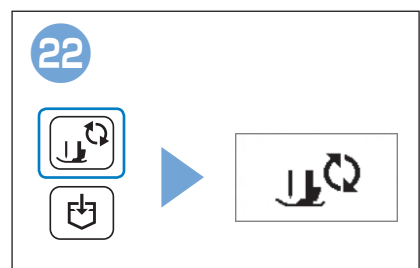
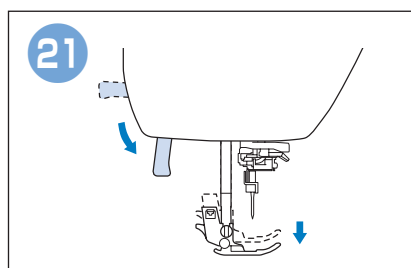
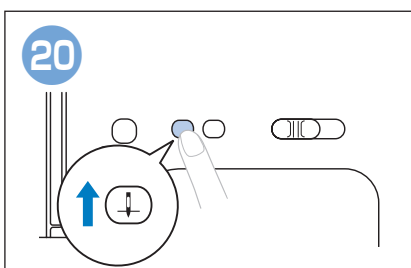
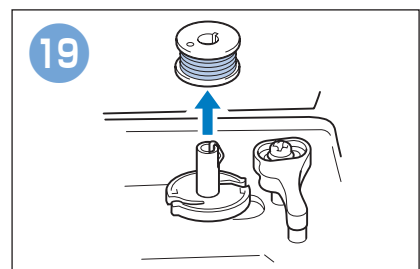
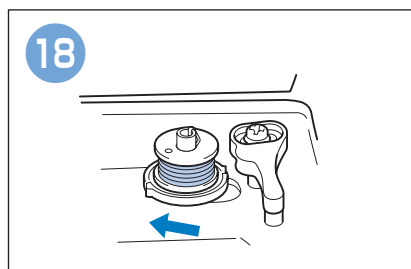
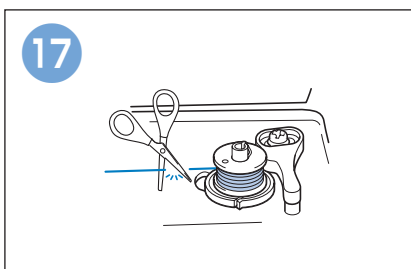
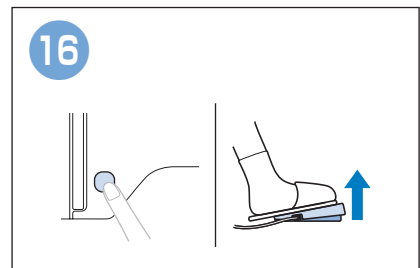
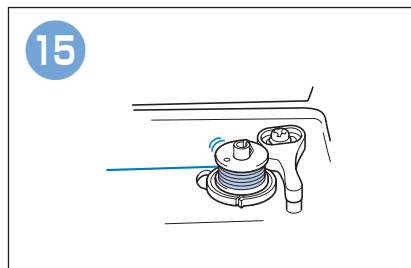
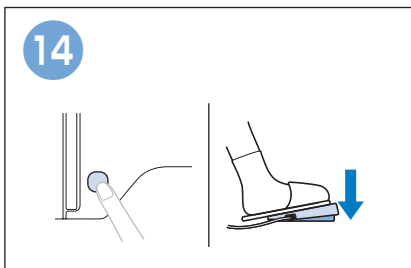
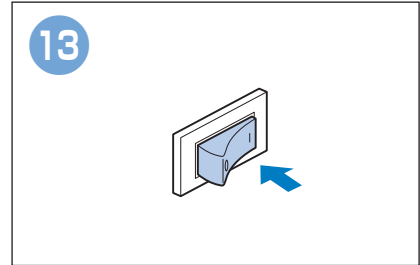
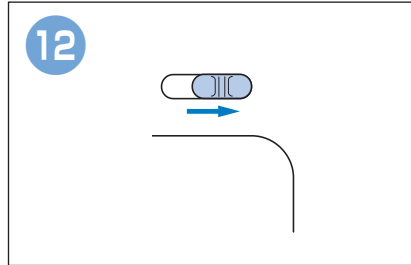
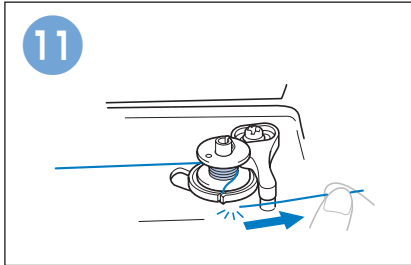
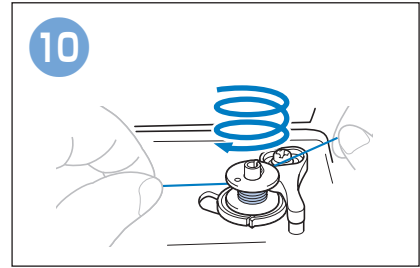
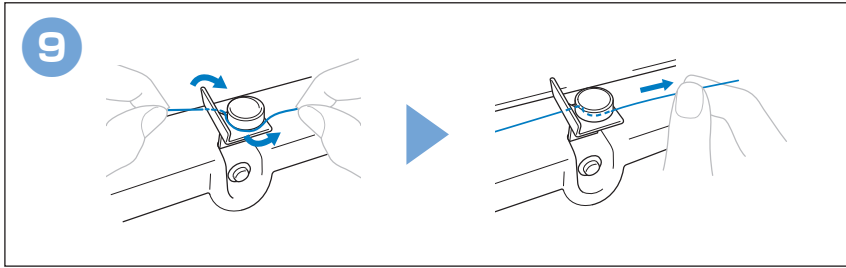

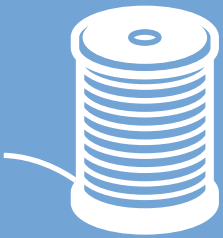

Upper Threading
Einfädeln des Oberfadens
Enfilage supérieur
Inrijgen van de bovendraad
Infilatura superiore
Hilo superior
Passagem da linha superior
Заправка верхней нити

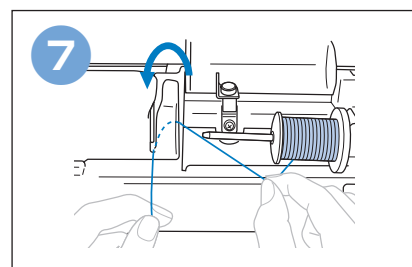
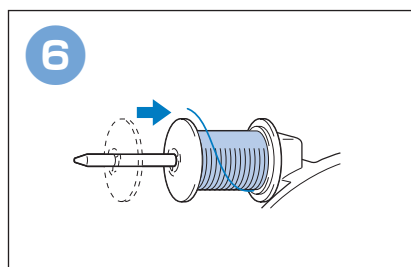
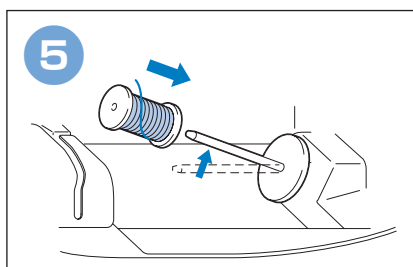
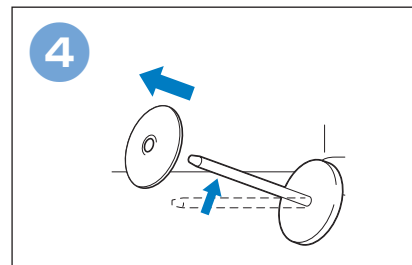
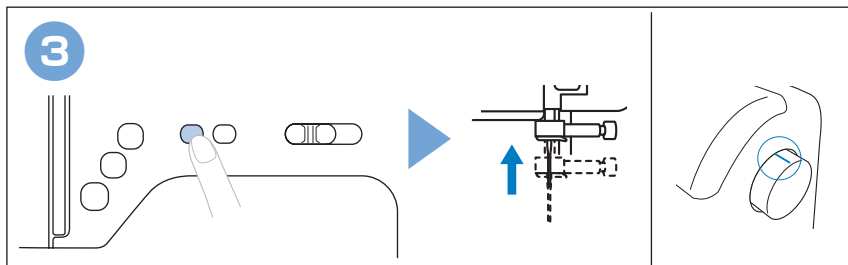
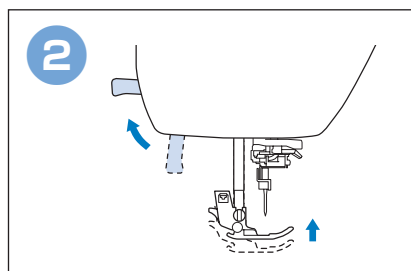
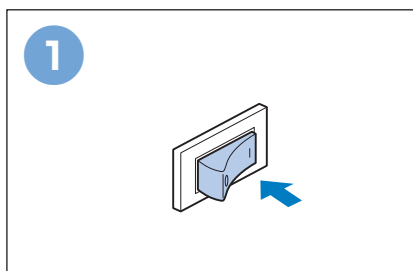
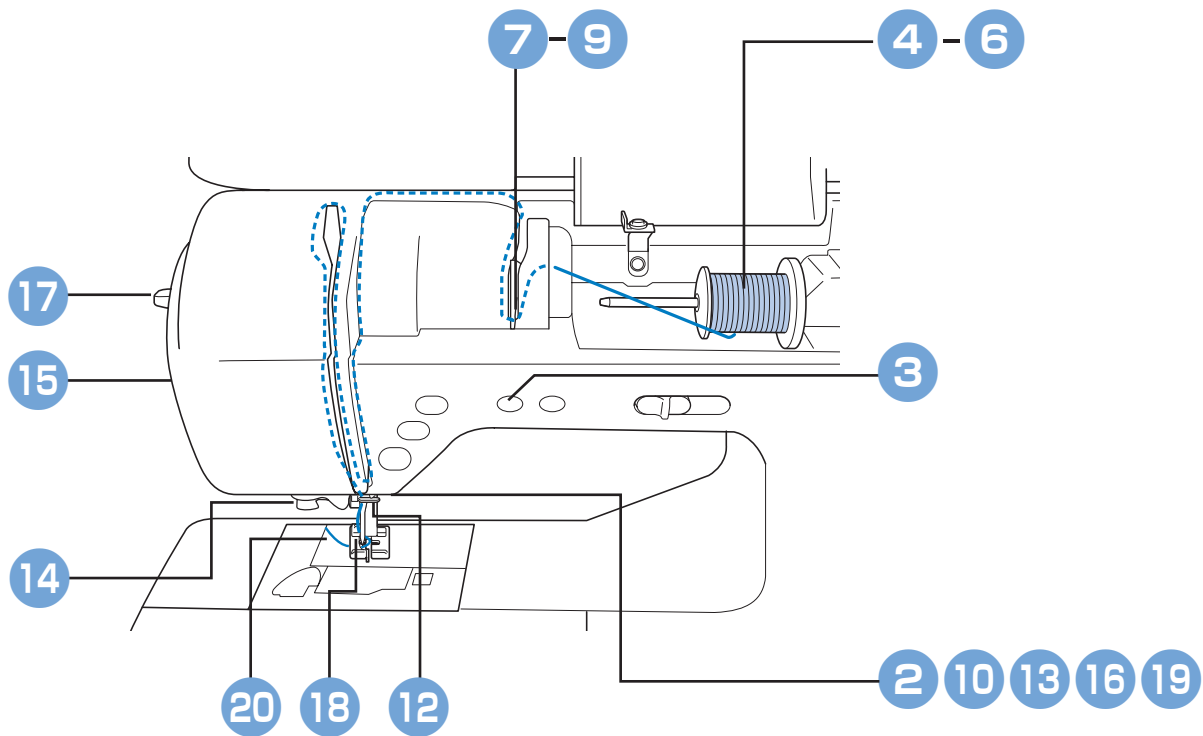

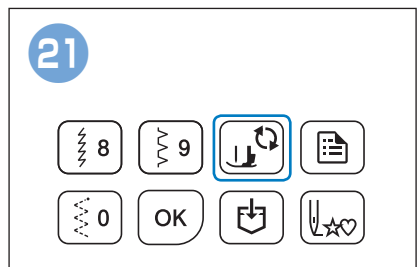
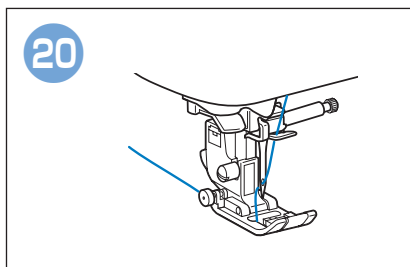
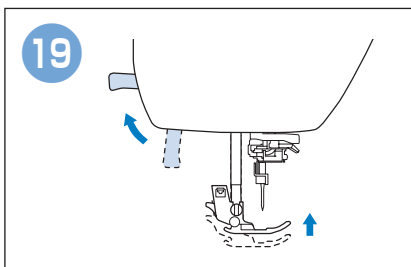
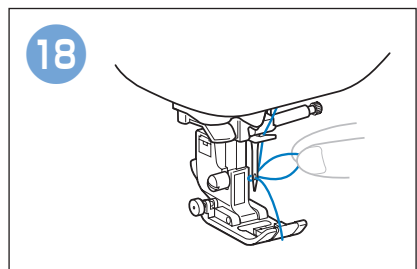
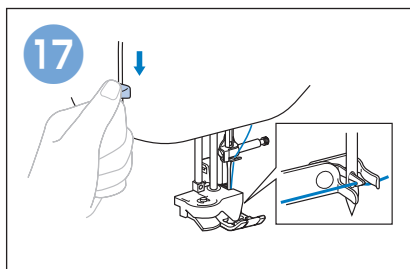
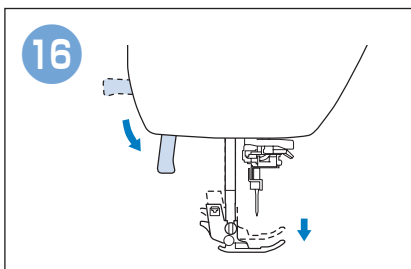
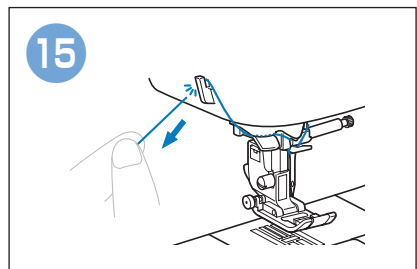
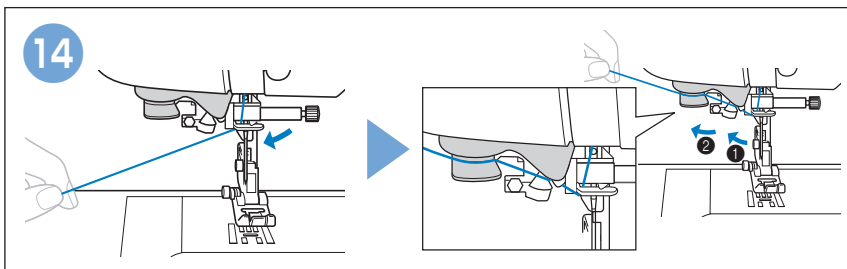
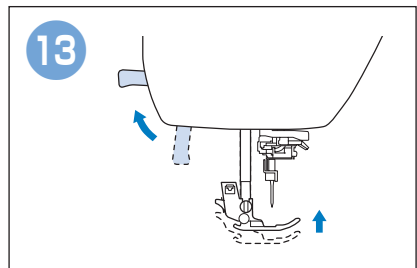
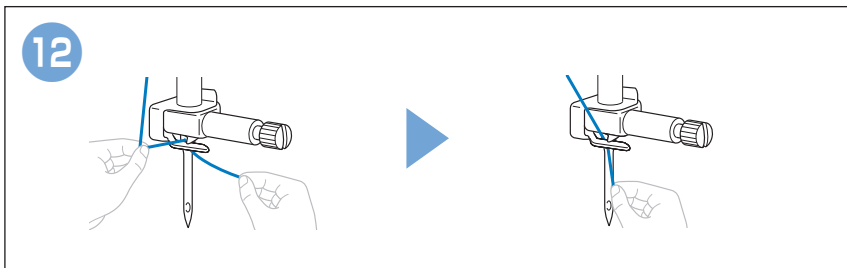
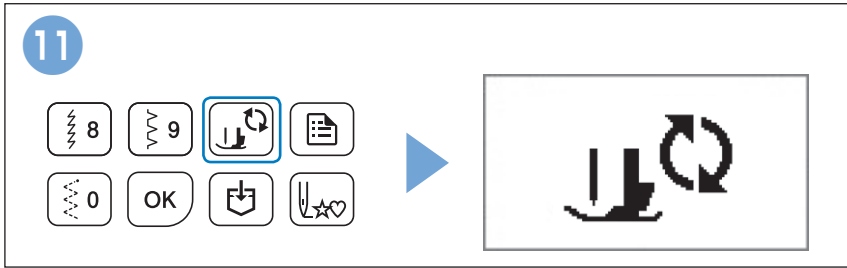
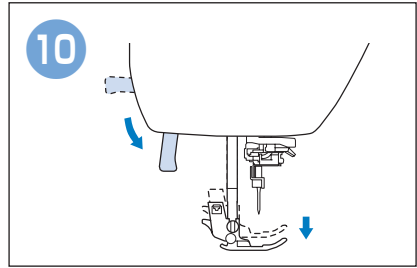
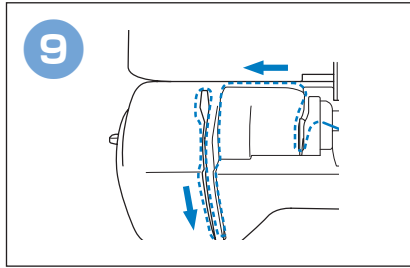
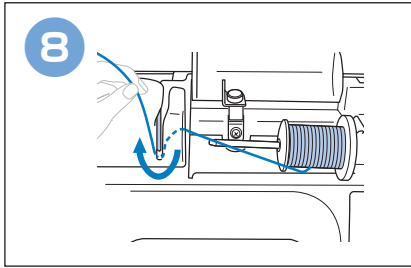

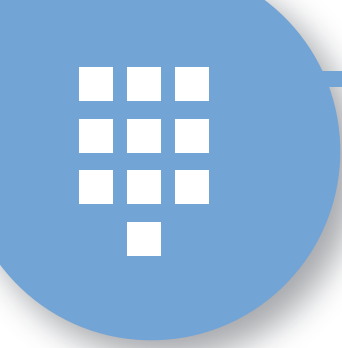

Selecting and Sewing Patterns
Auswählen und Nähen von Stichen
Sélection et couture de motifs
Steken selecteren en naaien
Selezione e cucitura di motivi
Seleccionar y coser patrones
Seleção e costura de padrões
Выбор швейных строчек

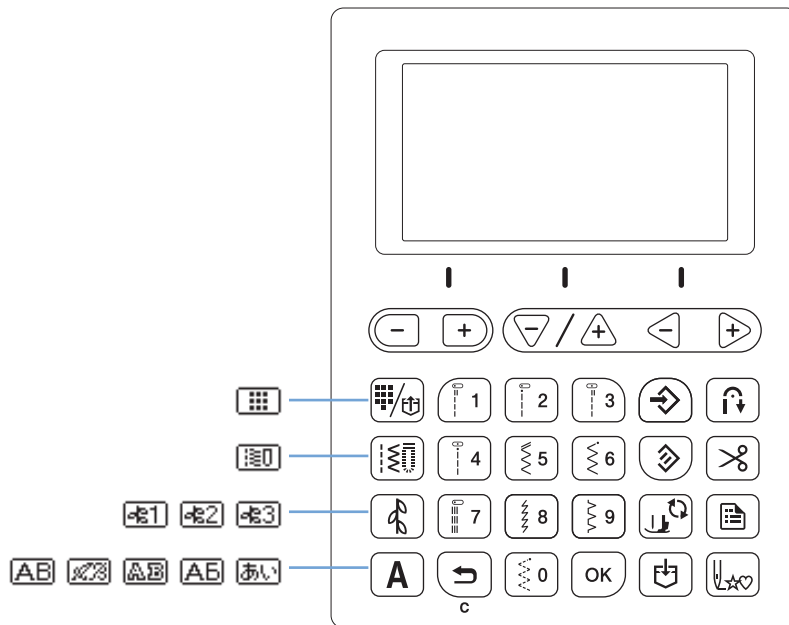

◆ Preset Utility Stitches
 ◆ Punti utili preimpostati

◆ Voreingestellte Nutztische
 ◆ Puntadas de utilidad predefinidas

◆ Préréglage des points de couture courants
 ◆ Pontos utilitários predefinidos

◆ Vooraf ingestelde naaisteken
 ◆ Предварительно заданные основные строчки

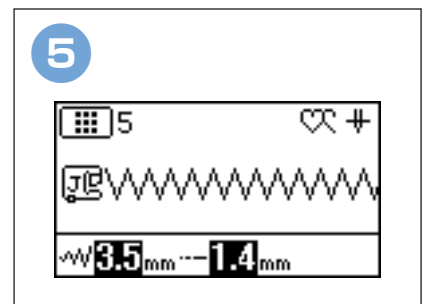
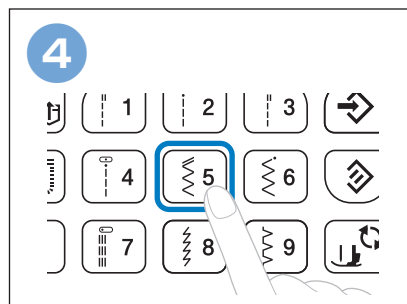
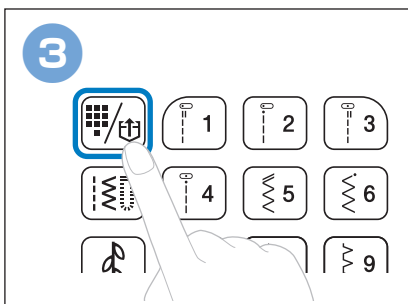
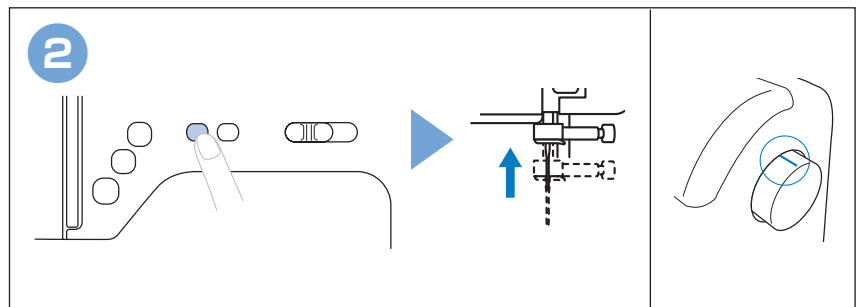
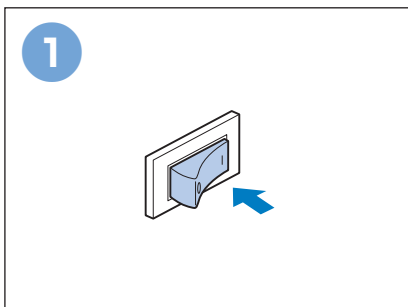

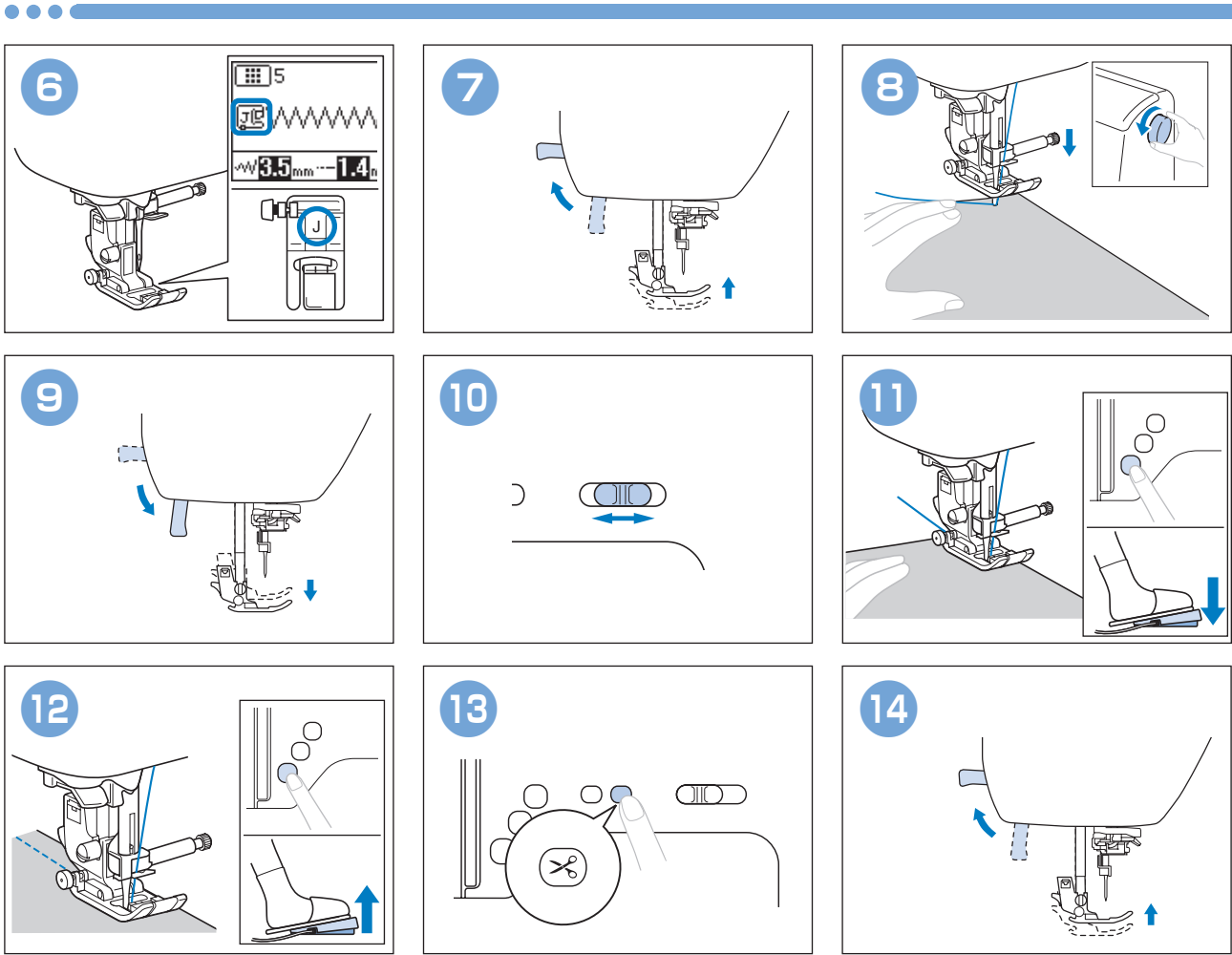

◆ Utility Stitches
◆ Punti utili

◆ Nutztstiche
◆ Puntadas de utilidad

◆ Points de couture courants
◆ Pontos utilitários

◆ Naaisteken
◆ Основные строчки

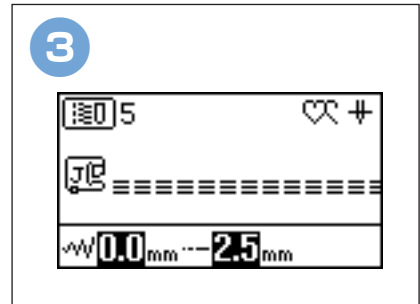
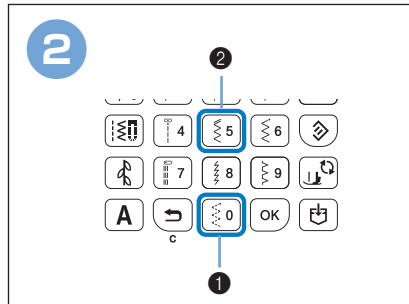
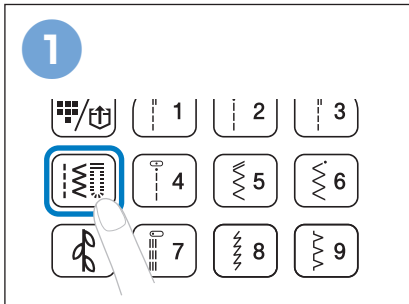

◆ Decorative Stitches ◆ Dekorstiche ◆ Points décoratifs ◆ Decoratieve steken
 ◆ Puntti decorativi ◆ Puntadas decorativas ◆ Pontos decorativos ◆ Декоративные строчки

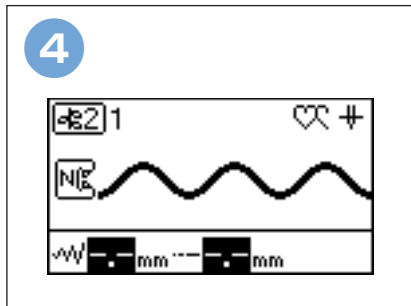
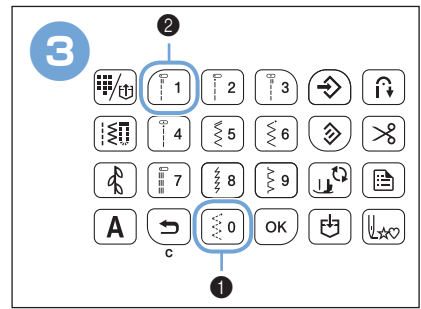
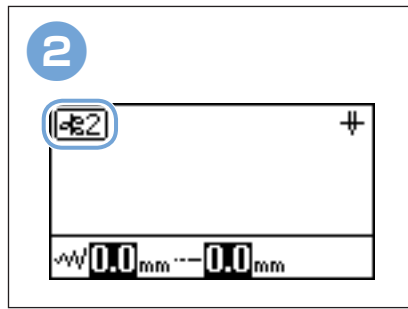
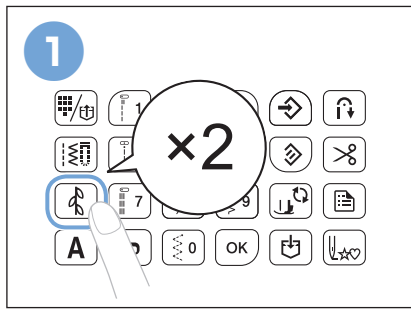

◆ Character stitches ◆ Buchstabenstiche ◆ Points de caractères ◆ Lettersteken
 ◆ Puntti a caratteri ◆ Puntadas de carácter ◆ Pontos de caracteres ◆ Символьные строчки

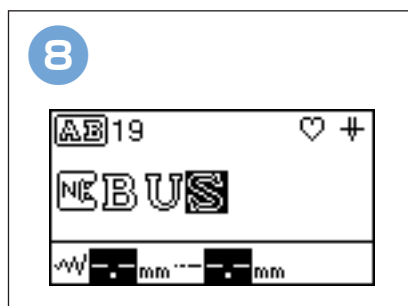
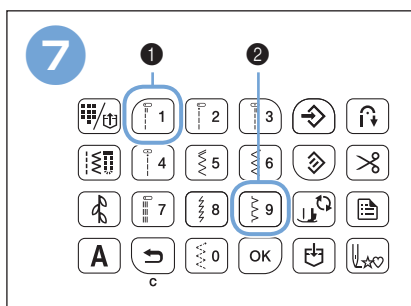
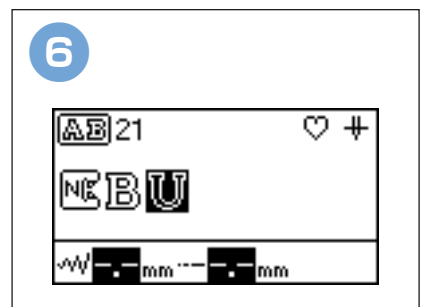
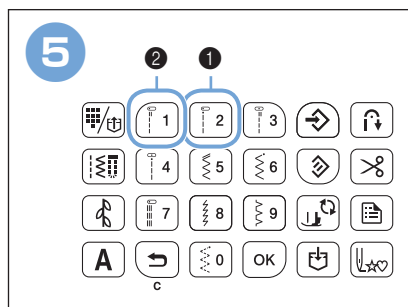
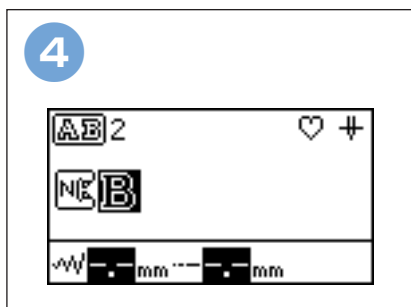
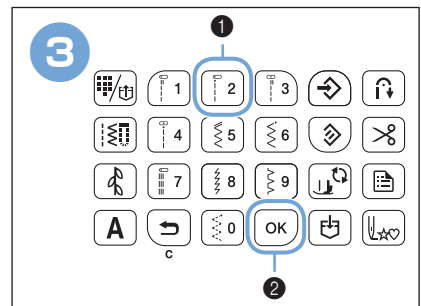
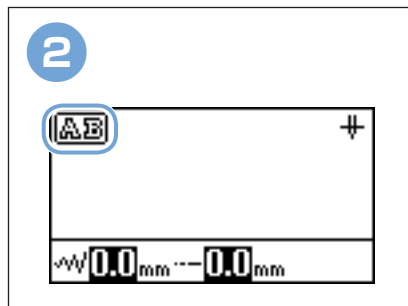
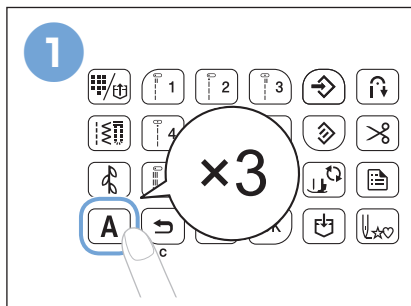



Summary of Stitch Patterns

Stich-Übersicht

Sommaire des motifs de point

Steken overzicht

Sommario degli schemi punto

Resumen de tipos de puntada

Resumo dos padrões de ponto

Рисунки строчек

◆ Preset Utility Stitches
◆ Punti utili preimpostati

◆ Voreingestellte Nutztische
◆ Puntadas de utilidad predefinidas

◆ Préréglage des points de couture courants
◆ Pontos utilitários predefinidos

◆ Vooraf ingestelde naaisteken
◆ Предварительно заданные основные строчки



◆ Utility Stitches
◆ Punti utili

◆ Nutztische
◆ Puntadas de utilidad

◆ Points de couture courants
◆ Pontos utilitários

◆ Naaisteken
◆ Основные строчки

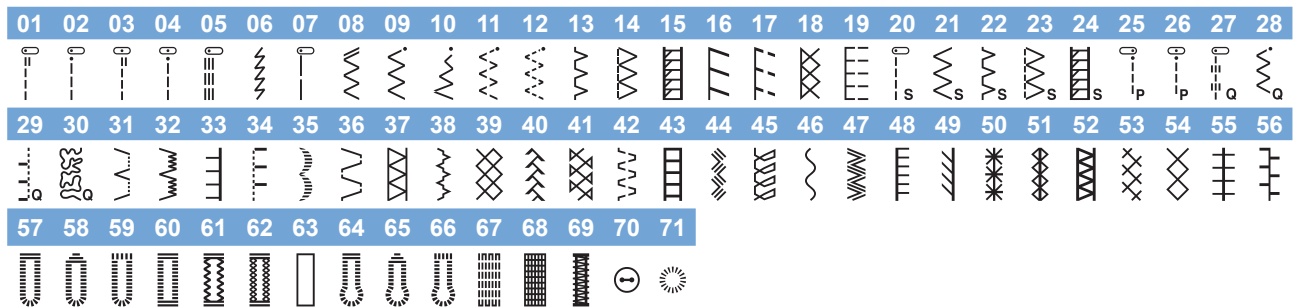

◆ Decorative Stitches
◆ Punti decorativi

◆ Dekorstiche
◆ Puntadas decorativas

◆ Points décoratifs
◆ Pontos decorativos

◆ Decoratieve steken
◆ Декоративные строчки

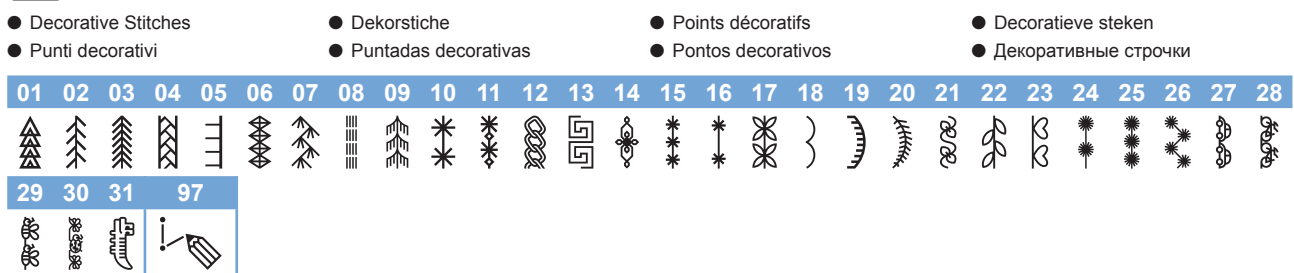

- * 31: Pattern for making adjustment, 97: MY CUSTOM STITCH
- * 31: Einstellungsmuster, 97: MY CUSTOM STITCH (Mein Stichdesign)
- * 31 : Motif d'ajustement, 97 : MY CUSTOM STITCH (MON POINT PERSONNALISÉ)
- * 31: patroon voor aanpassing, 97: MY CUSTOM STITCH
- * 31: Punto decorativo per eseguire la regolazione, 97: MY CUSTOM STITCH (PUNTI PERSONALIZZATI)
- * 31: Patrón para hacer el ajuste, 97: MY CUSTOM STITCH (Mi puntada preferida)
- * 31: Padrão para fazer ajustes, 97: MEU PONTO PERSONALIZADO
- * 31: Строчка для выполнения настройки, 97: MY CUSTOM STITCH (Моя строчка)



● Satin stitches (01-10)
7 mm satin stitches (11-27)
Cross stitch stitches (28-38)

● Satinstiche (01-10)
7 mm Satinstiche (11-27)
Kreuzstiche (28-38)

● Points plumetis (01-10)
Points plumetis 7 mm (11-27)
Points de croix (28-38)

● Satijnsteken (01-10)
7 mm satijnsteken (11-27)
Kruissteken (28-38)

● Puntii pieni (01-10)
Puntii pieni da 7 mm (11-27)
Puntii croce (28-38)

● Costuras para satén (01-10)
Puntadas satinadas de 7 mm (11-27)
Puntadas de punto de cruz (28-38)

● Pontos cheios (01-10)
Pontos cheios de 7 mm (11-27)
Pontos em ponto cruz (28-38)

● Атласные строчки (01-10)
Атласные строчки 7 мм (11-27)
Крестовидные строчки (28-38)

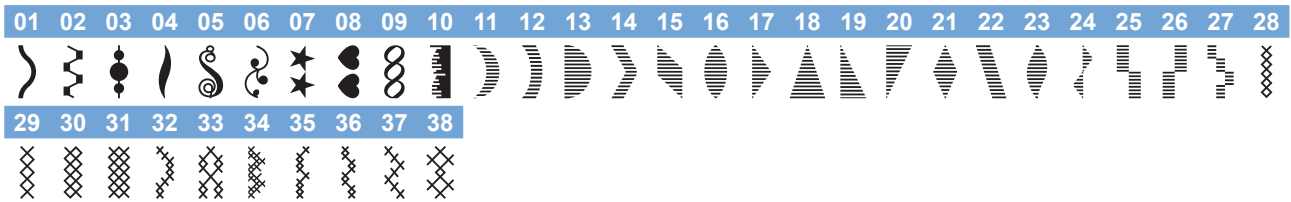

● Utility decorative stitch patterns

● Decoratieve naaisteken

● Padrões de ponto utilitário decorativo

● Dekorative Gebrauchsstichmuster

● Disegni/puntii utili decorativi

● Рисунки основных декоративных строчек

● Motifs de points décoratifs courants

● Puntadas decorativas utilitarias

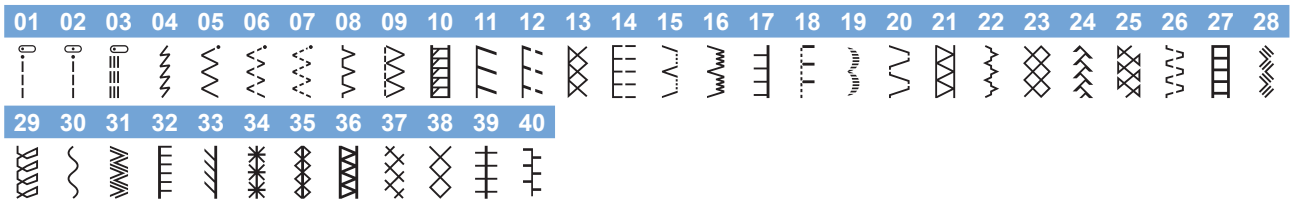

◆ Character stitches
◆ Puntti a caratteri

◆ Buchstabenstiche
◆ Puntadas de carácter

◆ Points de caractères
◆ Pontos de caracteres

◆ Lettersteken
◆ Символьные строчки

A x1 ▶ AB

● Gothic font
● Carattere Gothic

● Schriftart Gotisch
● Fuente gótica

● Police gothique
● Fonte gótica

● Gothic lettertype
● Готический шрифт

1	2	3	4	5	6	7	8	9	10	11	12	13	14	15	16	17	18	19	20	21	22	23	24	25	26
A	B	C	D	E	F	G	H	I	J	K	L	M	N	O	P	Q	R	S	T	U	V	W	X	Y	Z
27	28	29	30	31	32	33	34	35	36	37	38	39	40	41	42	43	44	45	46	47	48	49	50	51	52
0	1	2	3	4	5	6	7	8	9	#	%	-	+	x	÷	=	*	.	,	&	?	!	@	<	>
53	54	55	56	57	58	59	60	61	62	63	64	65	66	67	68	69	70	71	72	73	74	75	76	77	78
()	[]	/	\	~	©	®	™	“	”	”	’	‘	’	_	Ä	Å	Æ	Ç	Ð	Ñ	Ö	Ø	Œ
79	80																								
U	B																								

A x2 ▶ AB

● Handwriting font
● Carattere corsivo

● Schriftart Handschrift
● Fuente de escritura a mano

● Police manuscrite
● Fonte manuscrita

● Handschriftlettertype
● Рукописный шрифт

1	2	3	4	5	6	7	8	9	10	11	12	13	14	15	16	17	18	19	20	21	22	23	24	25	26
A	B	C	D	E	F	G	H	I	J	K	L	M	N	O	P	Q	R	S	T	U	V	W	X	Y	Z
27	28	29	30	31	32	33	34	35	36	37	38	39	40	41	42	43	44	45	46	47	48	49	50	51	52
0	1	2	3	4	5	6	7	8	9	#	%	-	+	x	÷	=	*	.	,	&	?	!	@	<	>
53	54	55	56	57	58	59	60	61	62	63	64	65	66	67	68	69	70	71	72	73	74	75	76	77	78
()	[]	/	\	~	©	®	™	“	”	”	’	‘	’	_	Ä	Å	Æ	Ç	Ð	Ñ	Ö	Ø	Œ
79	80																								
U	B																								

A ×3 ▶ **AB**

- Outline
- Contorno
- Umriss
- Con borde
- Contour
- Contorno
- Contour
- Контурный шрифт

1	2	3	4	5	6	7	8	9	10	11	12	13	14	15	16	17	18	19	20	21	22	23	24	25	26				
A	B	C	D	E	F	G	H	I	J	K	L	M	N	O	P	Q	R	S	T	U	V	W	X	Y	Z				
27	28	29	30	31	32	33	34	35	36	37	38	39	40	41	42	43	44	45	46	47	48	49	50	51	52				
0	1	2	3	4	5	6	7	8	9	#	%	-	+	×	÷	≡	*	.	,	&	?	!	@	<	>				
53	54	55	56	57	58	59	60	61	62	63	64	65	66	67	68	69	70	71	72	73	74	75	76	77	78				
()	[]	/	\	~	©	®	™	“	”	”	’	‘	’	_	À	Á	Â	Ã	Ä	Å	Æ	Ç	Ð	Ñ	Ö	Ø	Œ
79	80																												
Ù	Û																												

A ×4 ▶ **AB**

- Cyrillic font
- Carattere cirillico
- Schriftart Kyrillisch
- Fuente cirilica
- Police cyrillique
- Fonte cirilica
- Cyrillich lettertype
- Русский шрифт

1	2	3	4	5	6	7	8	9	10	11	12	13	14	15	16	17	18	19	20	21	22	23	24	25	26
А	Б	В	Г	Д	Е	Ё	Ж	З	И	Й	К	Л	М	Н	О	П	Р	С	Т	У	Ф	Х	Ц	Ч	Ш
27	28	29	30	31	32	33	34	35	36	37	38	39	40	41	42	43	44	45	46	47	48	49	50	51	52
Щ	ъ	ы	ь	э	ю	я	Г	Є	І	і	Ў	Ѡ	ѡ	Ј	Ј	њ	џ	Ѓ	Ѕ	К	0	1	2	3	4
53	54	55	56	57	58	59	60	61	62	63	64	65	66	67	68										
5	6	7	8	9	-	.	,	&	?	!	()	/	'	_										

A ×5 ▶ **あい**

- Japanese font
- Carattere giapponese
- Schriftart Japanisch
- Fuente japonesa
- Police japonaise
- Fonte japonesa
- Japans lettertype
- Японский шрифт

1	2	3	4	5	6	7	8	9	10	11	12	13	14	15	16	17	18	19	20	21	22	23	24	25	26
あいうえおあいうえおかきくけこがぎぐげごさしすせそざ																									
27	28	29	30	31	32	33	34	35	36	37	38	39	40	41	42	43	44	45	46	47	48	49	50	51	52
じずぜぞたちつてとだぢづでどっなにぬねのはひふへほば																									
53	54	55	56	57	58	59	60	61	62	63	64	65	66	67	68	69	70	71	72	73	74	75	76	77	78
びぶべぼびびふべぼまみむめもやゆよゃゅよらりるれろわ																									
79	80	81	82	83	84	85	86	87	88	89	90	91	92	93	94	95	96	97	98	99	100	101	102	103	104
をんアイウエオァィウヱォヴカキクケコガギグゲゴサシス																									
105	106	107	108	109	110	111	112	113	114	115	116	117	118	119	120	121	122	123	124	125	126	127	128	129	130
セソザジズゼゾタチツテトダヂヅデドッナニヌネノハヒフ																									
131	132	133	134	135	136	137	138	139	140	141	142	143	144	145	146	147	148	149	150	151	152	153	154	155	156
へホバビブベボパピプペポマミムメモヤユヨャュョラリル																									
157	158	159	160	161	162	163	164	165	166	167	168	169	170	171	172	173	174	175	176	177	178	179	180	181	182
レロフヲン0123456789〇ー二三四五六七八九十																									
183	184	185	186	187	188	189	190	191	192	193	194	195	196	197	198	199	200	201	202	203	204	205	206	207	208
&?!()-生年月日才保育幼稚園小中学校組部火水木金																									
209	210																								
土 _																									

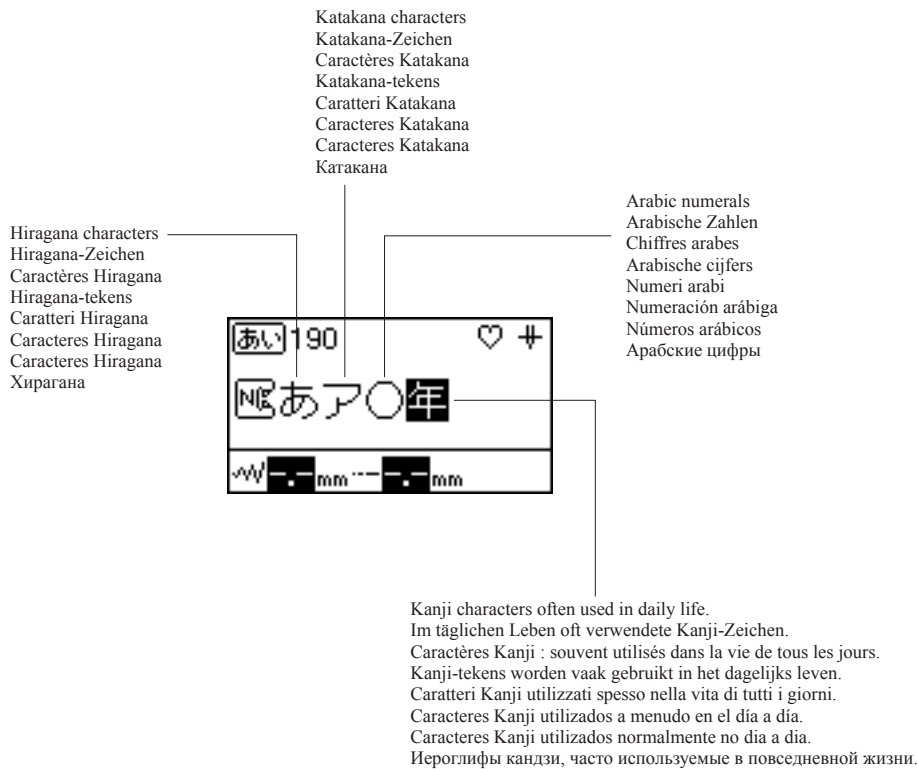

- Example of Kanji characters in daily life
- Beispiel für alltägliche Kanji-Zeichen
- Exemple de caractères Kanji dans la vie quotidienne
- Voorbeeld van Kanji-tekens in het dagelijks leven
- Esempio di caratteri kanji nella vita di ogni giorno
- Ejemplo de caracteres Kanji en la vida cotidiana
- Exemplo de caracteres Kanji no dia a dia
- Примеры использования иероглифов кандзи в повседневной жизни

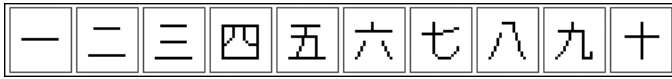

1, 2, 3, 4, 5, 6, 7, 8, 9, 10



Date of birth
Data di nascita

Geburtsdatum
Fecha de nacimiento

Date de naissance
Data de nascimento

Geboortedatum
Дата рождения

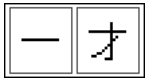

1 year old
1 anno di età

1 Jahr alt
1 año de edad

1 an
1 ano

1 jaar oud
Возраст 1 год



Nursery school
Asilo nido

Vorschule
Guardería

Crèche
Escola maternal

Peuterspeelzaal
Ясли



Kindergarten
Scuola materna

Kindergarten
Jardín de infancia

École maternelle
Jardim de infância

Kleuterschool
Детский сад



Elementary school
Scuola elementare

Grundschule
Escuela primaria

École primaire
Ensino básico

Basisschool
Начальная школа



Junior high school
Scuola superiore

Realschule
Escuela secundaria

Collège
Ensino médio

Middelbare school
Средняя школа



Group/Class
Gruppo/classe

Gruppe/Klasse
Grupo/Clase

Groupe/Classe
Grupo/Classe

Groep/klas
Группа, класс



Club/Division
Club/sezione

Club/Abteilung
Club/División

Club/Division
Clube/Divisão

Club/Divisie
Клуб, подразделение



Moon/Monday
Luna/lunedì

Mond/Montag
Luna/Lunes

Lune/Lundi
Lua/Segunda-feira

Maan/Maandag
Луна, понедельник



Fire/Tuesday
Fuoco/martedì

Feuer/Dienstag
Fuego/Martes

Feu/Mardi
Fogo/Terça-feira

Vuur/Dinsdag
Огонь, вторник



Water/Wednesday
Acqua/mercoledì

Wasser/Mittwoch
Agua/Miércoles

Eau/Mercredi
Água/Quarta-feira

Water/Woensdag
Вода, среда



Tree/Thursday
Albero/giovedì

Baum/Donnerstag
Árbol/Jueves

Arbre/Jeudi
Árvore/Quinta-feira

Boom/Donderdag
Дерево, четверг



Gold/Friday
Oro/venerdì

Gold/Freitag
Oro/Viernes

Or/Vendredi
Ouro/Sexta-feira

Goud/Vrijdag
Золото, пятница



Soil/Saturday
Terra/sabato

Erde/Samstag
Tierra/Sábado

Terre/Samedi
Terra/Sábado

Grond/Zaterdag
Земля, суббота



Sun/Sunday
Sole/domenica

Sonne/Sonntag
Sol/Domingo

Soleil/Dimanche
Sol/Domingo

Zon/Zondag
Солнце, воскресенье



January 1st (Monday)
1° gennaio (lunedì)

1. Januar (Montag)
1 de enero (lunes)

1er janvier (lundi)
1° de janeiro (Segunda-feira)

1 januari (maandag)
1 января (понедельник)

English
German
French
Dutch
Italian
Spanish
Portuguese-BR
Russian
888-H72
Printed in Vietnam



XG5478-101①

McGrp.Ru



Сайт техники и электроники

Наш сайт McGrp.Ru при этом не является просто хранилищем [инструкций по эксплуатации](#), это живое сообщество людей. Они общаются на форуме, задают вопросы о способах и особенностях использования техники. На все вопросы очень быстро находят ответы от таких же посетителей сайта, экспертов или администраторов. Вопрос можно задать как на форуме, так и в специальной форме на странице, где описывается интересующая вас техника.